

Installation Guide

Original Fitted Semi-Recessed Washbasin Unit

Important Information

- Read the instructions carefully.
- Check the product for any signs of damage and remove any protective film.
- It is recommended that a technically competent installer undertakes installation.
- It is the installer's responsibility to carry out a thorough assessment of the wall type and the weight of the cabinet and use appropriate fixings.
- Care should be taken when drilling walls to avoid any hidden wires or pipes.
- If the fascias are to be cut, use a saw with a fine-toothed blade ensuring that the room is well ventilated. Any cut edges should be sealed with PVA glue or silicone sealant to prevent the ingress of moisture.

Installation

Remove the shelf and turn the unit upside down. Push the legs firmly into the leg sockets.

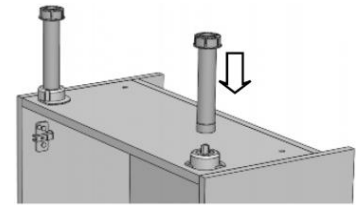

Stand the unit back on its legs against the wall. If fitting a run of units, fix them together through the gable panels. Try to hide the fixings where possible behind shelves or hinge plates.

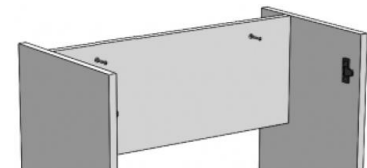

Adjust the legs on the units until they are level. Secure the units to the wall by drilling through the back rail and using suitable fixings for the wall type.

Door Hinge Adjustment

- To square the door against the cabinet, adjust screws A.
- To adjust the door closer to or further away from the cabinet, adjust screws B.
- To adjust the door vertically, slacken screws C. Re-tighten once the door is adjusted as required.
- To remove the door hinges from the cabinet, press button D.
- To remove the door hinges from the door, remove screws E.

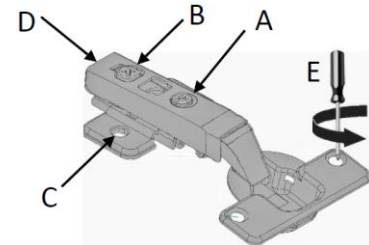

Care & Maintenance

Furniture should be regularly dusted with a soft cotton or micro-fibre cloth. For more thorough cleaning, occasionally wipe your furniture with a soft cloth dampened with a mild detergent solution. Surfaces should be thoroughly dried with a lint free cloth to prevent watermarks. Under no circumstances should solvent cleaning agents, bleach or abrasive cleaning agents or cloths be used. Spills should be removed immediately using a clean cloth. All bathroom furniture will deteriorate through prolonged periods of exposure to high levels of condensation so bathrooms must be adequately ventilated using suitable extraction. Failure to ensure adequate ventilation may invalidate your guarantee.

Installation Guide

Original Fitted Double Base Unit

Important Information

- Read the instructions carefully.
- Check the product for any signs of damage and remove any protective film.
- It is recommended that a technically competent installer undertakes installation.
- It is the installer's responsibility to carry out a thorough assessment of the wall type and the weight of the cabinet and use appropriate fixings.
- Care should be taken when drilling walls to avoid any hidden wires or pipes.

Installation

Remove the shelf, turn the unit upside down and push the legs firmly into the leg sockets.

Stand the unit back on its legs against the wall. If fitting a run of units, fix them together through the gable panels. Where possible, try to hide the fixings behind shelves or hinge plates.

Adjust the legs on the units until they are level.

Secure the unit to the wall by drilling through the back rail and using suitable fixings for the wall type.

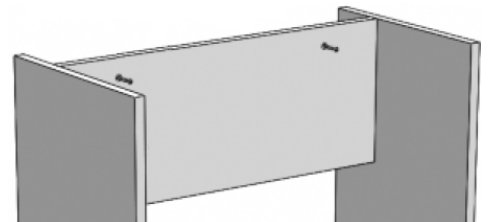
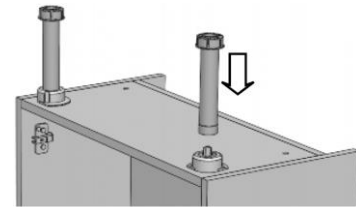

Door hinge adjustment

- To square the door against the cabinet, adjust screws A.
- To adjust the door closer to or further away from the cabinet, adjust screws B.
- To adjust the door vertically, slacken screws C. Re-tighten once the door is adjusted as required.
- To remove the door hinges from the cabinet, press button D.
- To remove the door hinges from the door, remove screws E.

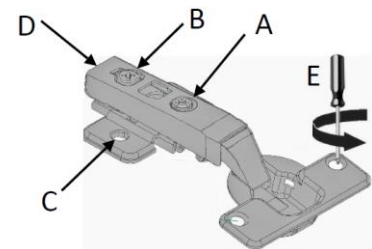

Care & Maintenance

Furniture should be regularly dusted with a soft cotton or micro-fibre cloth. For more thorough cleaning, occasionally wipe your furniture with a soft cloth dampened with a mild detergent solution. Surfaces should be thoroughly dried with a lint free cloth to prevent watermarks. Under no circumstances should solvent cleaning agents, bleach or abrasive cleaning agents or cloths be used. Spills should be removed immediately using a clean cloth. All bathroom furniture will deteriorate through prolonged periods of exposure to high levels of condensation so bathrooms must be adequately ventilated using suitable extraction. Failure to ensure adequate ventilation may invalidate your guarantee.

Installation Guide

Original Fitted Back-To-Wall Toilet Unit

Important Information

- Read the instructions carefully.
- Check the product for any signs of damage and remove any protective film.
- It is recommended that a technically competent installer undertakes installation.
- It is the installer's responsibility to carry out a thorough assessment of the wall type and the weight of the cabinet and use appropriate fixings.
- Care should be taken when drilling walls to avoid any hidden wires or pipes.

Installation

Remove the top fascia panel first by pulling it away from the cabinet with equal force on each side.

Turn the unit upside down. Push the legs firmly into the leg sockets.

To secure the WC unit against the wall, drill through the rear top rail. Fix the unit in position using suitable fixings.

If fitting a run of units, fix them together through the gable panels. Where possible, try to hide the fixings behind shelves or hinge plates.

To cut the lower fascia panel to accommodate the soil pipe and cistern flush pipe, use a jigsaw with a fine-toothed blade suitable for timber. Ensure that the room is well ventilated when cutting the material.

All cut edges must be sealed with PVA glue or good-quality, sanitary grade silicone sealant to prevent the ingress of moisture.

Fit the top fascia panel last, after plumbing connections have been made and installation completed.

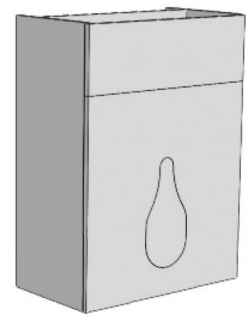
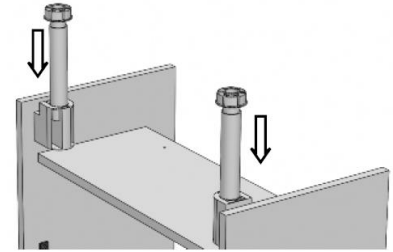

Care & Maintenance

Furniture should be regularly dusted with a soft cotton or micro-fibre cloth. For more thorough cleaning, occasionally wipe your furniture with a soft cloth dampened with a mild detergent solution. Surfaces should be thoroughly dried with a lint free cloth to prevent watermarks. Under no circumstances should solvent cleaning agents, bleach or abrasive cleaning agents or cloths be used. Spills should be removed immediately using a clean cloth. All bathroom furniture will deteriorate through prolonged periods of exposure to high levels of condensation so bathrooms must be adequately ventilated using suitable extraction. Failure to ensure adequate ventilation may invalidate your guarantee.

Installation Guide

Original Fitted Single Door Mirror Cabinet

Important Information

- Read the instructions carefully.
- Check the product for any signs of damage and remove any protective film.
- It is the installer's responsibility to carry out a thorough assessment of wall type and the weight of the cabinet and use appropriate fixings.
- Care should be taken when drilling walls to avoid any hidden wires or pipes.
- To prevent the cabinet falling down this product must be fixed using the wall attachment device provided.

Installation

Mark a horizontal line on the wall at the required height **X---X**. Ensure that the wall brackets will fit inside the width of the cabinet and are equally spaced to ensure even distribution of weight. Secure the wall brackets to the wall using suitable fixings.

Hook the unit onto the wall brackets ensuring that the brackets are securely located.

To alter the position of the cabinet on the wall, adjust the two screws in each hanging bracket. The top screws will move the cabinet closer to or further away from the wall. The lower screws will move the cabinet up and down.

A securing screw should be fitted through the back of the unit through the fixed back of the cabinet and into the wall, this will help to stabilise the unit.

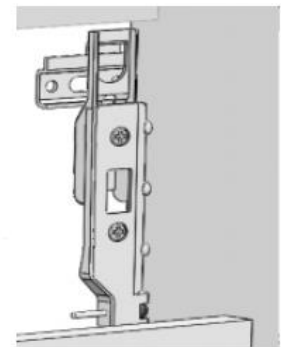
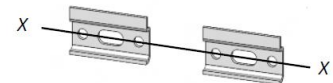

Door Hinge Adjustment

- To square the door against the cabinet, adjust screws A.
- To adjust the door closer to or further away from the cabinet, adjust screws B.
- To adjust the door vertically, slacken screws C. Re-tighten once the door is adjusted as required.
- To remove the door hinges from the cabinet, press button D.
- To remove the door from the door hinges, remove screws E.

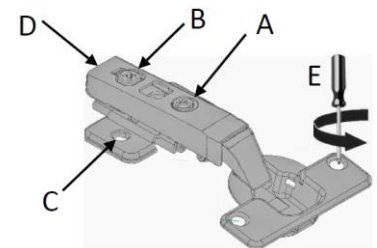

Care & Maintenance

Furniture should be regularly dusted with a soft cotton or micro-fibre cloth. For more thorough cleaning, occasionally wipe your furniture with a soft cloth dampened with a mild detergent solution. Surfaces should be thoroughly dried with a lint free cloth to prevent watermarks. Under no circumstances should solvent cleaning agents, bleach or abrasive cleaning agents or cloths be used. Glass or mirrored panels should be cleaned using a non-solvent based glass cleaner and a soft cloth. Spills should be removed immediately using a clean cloth. All bathroom furniture will deteriorate through prolonged periods of exposure to high levels of condensation so bathrooms must be adequately ventilated using suitable extraction. Failure to ensure adequate ventilation may invalidate your guarantee.

Installation Guide

Original Fitted Tissue Roll Unit

Important Information

- Read the instructions carefully.
- Check the product for any signs of damage and remove any protective film.
- It is recommended that a technically competent installer undertakes installation.
- It is the installer's responsibility to carry out a thorough assessment of the wall type and the weight of the cabinet and use appropriate fixings.
- Care should be taken when drilling walls to avoid any hidden wires or pipes.

Installation

Turn the unit upside down and push the legs firmly into the leg sockets.

Stand the unit back on its legs against the wall. If fitting a run of units, fix them together through the gable panels. Where possible, try to hide the fixings behind shelves or hinge plates.

Adjust the legs on the units until they are level.

Secure the unit to the wall by drilling through the back rail and using suitable fixings for the wall type.

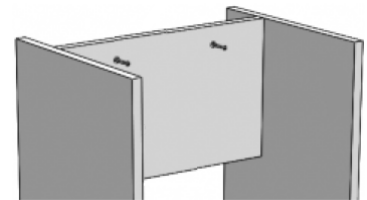
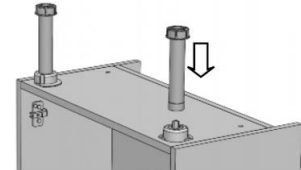

Door Hinge Adjustment

- To square the door against the cabinet, adjust screws A.
- To adjust the door closer to or further away from the cabinet, adjust screws B.
- To adjust the door vertically, slacken screws C. Re-tighten once the door is adjusted as required.
- To remove the door hinges from the cabinet, press button D.
- To remove the door hinges from the door, remove screws E.

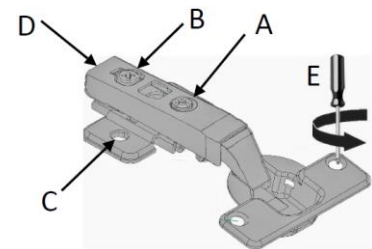

Care & Maintenance

Furniture should be regularly dusted with a soft cotton or micro-fibre cloth. For more thorough cleaning, occasionally wipe your furniture with a soft cloth dampened with a mild detergent solution. Surfaces should be thoroughly dried with a lint free cloth to prevent watermarks. Under no circumstances should solvent cleaning agents, bleach or abrasive cleaning agents or cloths be used. Spills should be removed immediately using a clean cloth. All bathroom furniture will deteriorate through prolonged periods of exposure to high levels of condensation so bathrooms must be adequately ventilated using suitable extraction. Failure to ensure adequate ventilation may invalidate your guarantee.

Installation Guide

Original Fitted Toilet Unit Without Cistern

Important Information

- Read the instructions carefully.
- Check the product for any signs of damage and remove any protective film.
- It is recommended that a technically competent installer undertakes installation.
- It is the installer's responsibility to carry out a thorough assessment of the wall type and the weight of the cabinet and use appropriate fixings.
- Care should be taken when drilling walls to avoid any hidden wires or pipes.

Installation

To fit a concealed cistern into the WC unit, pull the front top fascia away from the cabinet with equal force on each side. The lower front panel can now be lifted upwards away from the cabinet. Secure the cistern in position according to the instructions supplied with it.

To secure the WC unit against the wall, drill through the rear top rail. Fix the unit in position using suitable fixings.

To cut the lower front panel to accommodate the toilet soil pipe and cistern flush pipe, use a jigsaw with a fine-toothed blade suitable for timber. Ensure that the room is well ventilated when cutting the material.

All cut edges must be sealed with paint, PVA glue or good-quality sanitary grade silicone sealant to prevent the ingress of moisture.

Re-fit the top fascia panel last, after plumbing connections have been made and installation completed.

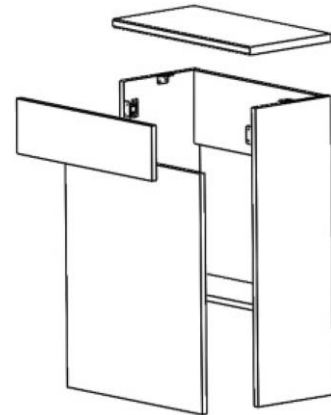

Care & Maintenance

Furniture should be regularly dusted with a soft cotton or micro-fibre cloth. For more thorough cleaning, occasionally wipe your furniture with a soft cloth dampened with a mild detergent solution. Surfaces should be thoroughly dried with a lint free cloth to prevent watermarks. Under no circumstances should solvent cleaning agents, bleach or abrasive cleaning agents or cloths be used. Glass or mirrored panels should be cleaned using a non-solvent based glass cleaner and a soft cloth. Spills should be removed immediately using a clean cloth. All bathroom furniture will deteriorate through prolonged periods of exposure to high levels of condensation so bathrooms must be adequately ventilated using suitable extraction. Failure to ensure adequate ventilation may invalidate your guarantee.

Installation Guide

Original Fitted Tall Unit

Important Information

- Read the instructions carefully.
- Check the product for any signs of damage and remove any protective film.
- It is recommended that a technically competent installer undertakes installation.
- It is the installer's responsibility to carry out a thorough assessment of the wall type and the weight of the cabinet and use appropriate fixings.
- Care should be taken when drilling walls to avoid any hidden wires or pipes.
- To prevent the cabinet falling down this product must be fixed using the wall attachment device provided.

Installation

Mark a horizontal line on the wall at the required height **X---X**. Ensure that the wall brackets will fit inside the width of the cabinet and are equally spaced. Secure the wall brackets to the wall using suitable fixings.

Hook the unit onto the wall brackets ensuring that the brackets are securely located.

To adjust the position of the cabinet on the wall, use the two screws in each hanging bracket. The top screws will move the cabinet closer to or further away from the wall. The lower screws will move the cabinet up and down.

If this cabinet is being fitted in a run, secure the units together with suitable fixings through the gables. Try to hide the fixings where possible behind shelves or hinge plates.

A securing screw should be fitted through the back of the unit through the fixed back rail of the cabinet and into the wall. This will help to stabilise the unit.

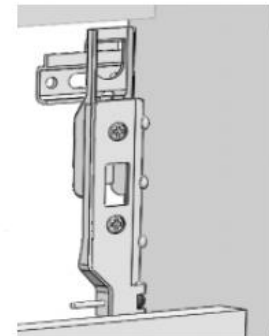
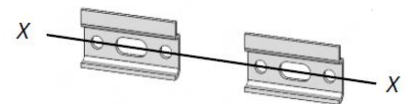

Door Hinge Adjustment

- To square the door against the cabinet, adjust screws A.
- To adjust the door closer to or further away from the cabinet, adjust screws B.
- To adjust the door vertically, slacken screws C. Re-tighten once the door is adjusted as required.
- To remove the door hinges from the cabinet, press button D.
- To remove the door hinges from the door, remove screws E.

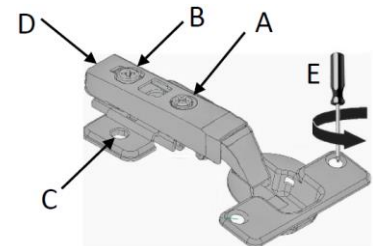

Care & Maintenance

Furniture should be regularly dusted with a soft cotton or micro-fibre cloth. For more thorough cleaning, occasionally wipe your furniture with a soft cloth dampened with a mild detergent solution. Surfaces should be thoroughly dried with a lint free cloth to prevent watermarks. Under no circumstances should solvent cleaning agents, bleach or abrasive cleaning agents or cloths be used. Spills should be removed immediately using a clean cloth. All bathroom furniture will deteriorate through prolonged periods of exposure to high levels of condensation so bathrooms must be adequately ventilated using suitable extraction. Failure to ensure adequate ventilation may invalidate your guarantee.

Installation Guide

Original Fitted Single Base Unit

Important Information

- Read the instructions carefully.
- Check the product for any signs of damage and remove any protective film.
- It is recommended that a technically competent installer undertakes installation.
- It is the installer's responsibility to carry out a thorough assessment of the wall type and the weight of the cabinet and use appropriate fixings.
- Care should be taken when drilling walls to avoid any hidden wires or pipes.

Installation

Remove the shelf, turn the unit upside down and push the legs firmly into the leg sockets.

Stand the unit back on its legs against the wall. If fitting a run of units, fix them together through the gable panels. Where possible, try to hide the fixings behind shelves or hinge plates.

Adjust the legs on the units until they are level.

Secure the unit to the wall by drilling through the back rail and using suitable fixings for the wall type.

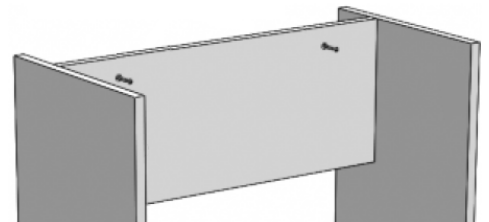
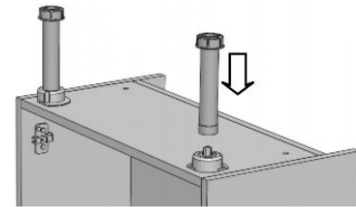

Door Hinge Adjustment

- To square the door against the cabinet, adjust screws A.
- To adjust the door closer to or further away from the cabinet, adjust screws B.
- To adjust the door vertically, slacken screws C. Re-tighten once the door is adjusted as required.
- To remove the door hinges from the cabinet, press button D.
- To remove the door hinges from the door, remove screws E.

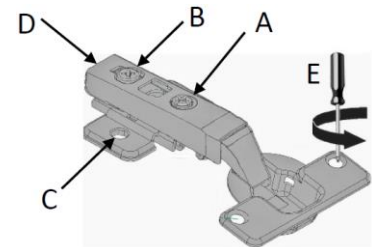

Care & Maintenance

Furniture should be regularly dusted with a soft cotton or micro-fibre cloth. For more thorough cleaning, occasionally wipe your furniture with a soft cloth dampened with a mild detergent solution. Surfaces should be thoroughly dried with a lint free cloth to prevent watermarks. Under no circumstances should solvent cleaning agents, bleach or abrasive cleaning agents or cloths be used. Spills should be removed immediately using a clean cloth. All bathroom furniture will deteriorate through prolonged periods of exposure to high levels of condensation so bathrooms must be adequately ventilated using suitable extraction. Failure to ensure adequate ventilation may invalidate your guarantee.

Installation Guide

Original Fitted Single Wall Unit

Important Information

- Read the instructions carefully.
- Check the product for any signs of damage and remove any protective film.
- It is the installer's responsibility to carry out a thorough assessment of wall type and the weight of the cabinet and use appropriate fixings.
- Care should be taken when drilling walls to avoid any hidden wires or pipes.
- To prevent the cabinet falling down this product must be fixed using the wall attachment device provided.

Installation

Mark a horizontal line on the wall at the required height **X---X**. Ensure that the wall brackets will fit inside the width of the cabinet and are equally spaced to ensure even distribution of weight. Secure the wall brackets to the wall using suitable fixings.

Hook the unit onto the wall brackets ensuring that the brackets are securely located.

To alter the position of the cabinet on the wall, adjust the two screws in each hanging bracket. The top screws will move the cabinet closer to or further away from the wall. The lower screws will move the cabinet up and down.

If this cabinet is being fitted in a run, secure the units together with suitable fixings through the gables. Try to hide the fixings where possible behind shelves or hinge plates.

A securing screw should be fitted through the back of the unit through the fixed back of the cabinet and into the wall, this will help to stabilise the unit.

Fitting Doors

To fit the doors, remove the door hinges from the cabinet by pressing button D. Lay the door face down and push the door hinges into the pre-drilled holes.

Secure them in place by tightening screws E.

To re-fit the door hinges, push the hinge arm onto the mounting plate from the front. Push the rear of the hinge arm onto the plate until a click is heard.

Door Hinge Adjustment

- To square the door against the cabinet, adjust screws A.
- To adjust the door closer to or further away from the cabinet, adjust screws B.
- To adjust the door vertically, slacken screws C. Re-tighten once the door is adjusted as required.
- To remove the door hinges from the cabinet, press button D.
- To remove the door hinges from the door, remove screws E.

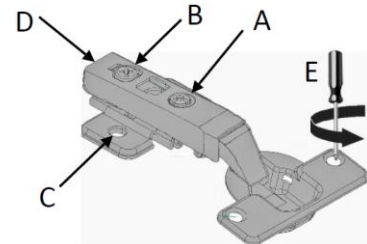

Care & Maintenance

Furniture should be regularly dusted with a soft cotton or micro-fibre cloth. For more thorough cleaning, occasionally wipe your furniture with a soft cloth dampened with a mild detergent solution. Surfaces should be thoroughly dried with a lint free cloth to prevent watermarks. Under no circumstances should solvent cleaning agents, bleach or abrasive cleaning agents or cloths be used. Spills should be removed immediately using a clean cloth. All bathroom furniture will deteriorate through prolonged periods of exposure to high levels of condensation so bathrooms must be adequately ventilated using suitable extraction. Failure to ensure adequate ventilation may invalidate your guarantee.

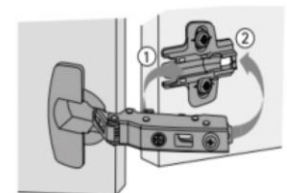
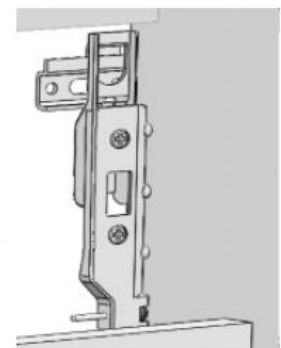
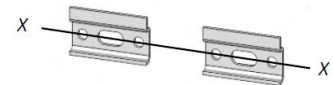

Installation Guide

Original Fitted Double Mirror Cabinet

Important Information

- Read the instructions carefully.
- Check the product for any signs of damage and remove any protective film.
- It is the installer's responsibility to carry out a thorough assessment of wall type and the weight of the cabinet and use appropriate fixings.
- Care should be taken when drilling walls to avoid any hidden wires or pipes.
- To prevent the cabinet falling down this product must be fixed using the wall attachment device provided.

Installation

Mark a horizontal line on the wall at the required height **X---X**. Ensure that the wall brackets will fit inside the width of the cabinet and are equally spaced to ensure even distribution of weight. Secure the wall brackets to the wall using suitable fixings.

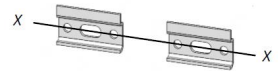

Hook the unit onto the wall brackets ensuring that the brackets are securely located.

To alter the position of the cabinet on the wall, adjust the two screws in each hanging bracket. The top screws will move the cabinet closer to or further away from the wall. The lower screws will move the cabinet up and down.

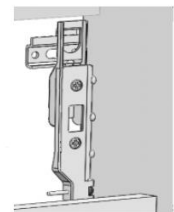

If this cabinet is being fitted in a run, secure the units together with suitable fixings through the gables. Try to hide the fixings where possible behind shelves or hinge plates.

A securing screw should be fitted through the back of the unit through the fixed back of the cabinet and into the wall, this will help to stabilise the unit.

Fitting Hinges to Cabinet

Hook the front of the door hinge onto the plate fitted to the inside of the cabinet. Push the back of the door hinge firmly against the plate until it clicks (see diagrams). Ensure that the hinge is securely fitted to the plate.

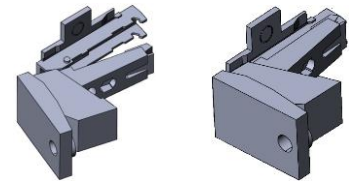

Door Hinge Adjustment

- To square the door against the cabinet, adjust screws A.
- To adjust the door closer to or further away from the cabinet, adjust screws B.
- To adjust the door vertically, slacken screws C. Re-tighten once the door is adjusted as required.
- To remove the door hinges from the cabinet, press button D.
- To remove the door hinges from the door, remove screws E.

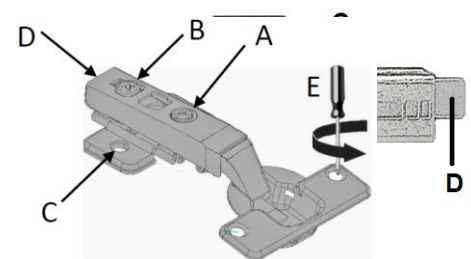

Care & Maintenance

Furniture should be regularly dusted with a soft cotton or micro-fibre cloth. For more thorough cleaning, occasionally wipe your furniture with a soft cloth dampened with a mild detergent solution. Surfaces should be thoroughly dried with a lint free cloth to prevent watermarks. Under no circumstances should solvent cleaning agents, bleach or abrasive cleaning agents or cloths be used. Glass or mirrored panels should be cleaned using a non-solvent based glass cleaner and a soft cloth. Spills should be removed immediately using a clean cloth. All bathroom furniture will deteriorate through prolonged periods of exposure to high levels of condensation so bathrooms must be adequately ventilated using suitable extraction. Failure to ensure adequate ventilation may invalidate your guarantee.

Installation Guide

Original Fitted Bath Side Panel

Important Information

- Read the instructions carefully.
- Check the product for any signs of damage and remove any protective film.
- It is recommended that a technically competent installer undertakes installation.
- It is the installer's responsibility to carry out a thorough assessment of the wall type and use appropriate fixings.
- Care should be taken when drilling walls to avoid any hidden wires or pipes.

Installation

Set the height of the bath to suit the height of the bath panel according to the instructions supplied with the bath.



Ensure that when the brackets and bath panel are fitted, the panel sits 4mm proud of the bath rim.

If you are installing this side panel in conjunction with an end panel, fit the end panel first according to the instructions supplied with it.

Screw three black Keku clips to the underside of the wooden batten underneath the bath rim using the screws provided. The three clips should be equally spaced along the length of the bath. Use the diagram as a guide to how the Keku clips are fitted.

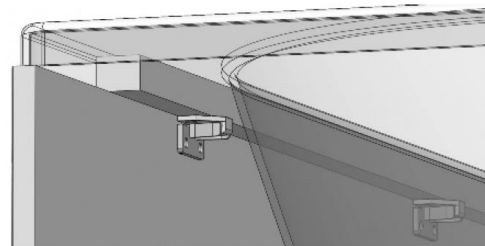

The matching Keku clips should be screwed to the rear of the bath panel using the screws supplied. Measure carefully to ensure that the clips on the rear of the bath panel will engage with the clips screwed to the bath.

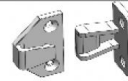

If the bath panel is being fitted between two walls, the two "L" brackets should be secured to the walls to prevent the panel from being pushed inwards. Ensure suitable fixings are used.

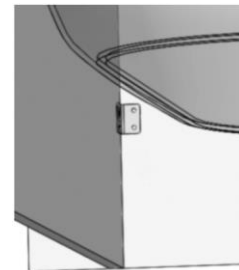

If the bath panel is being used in conjunction with an end panel, secure one "L" bracket to the wall to prevent the panel from being pushed inwards. On the opposite side to the wall, secure the bath panel in place using a Keku clip. This Keku clip is supplied with the end panel, along with instruction on how it is fitted.

Care & Maintenance

Furniture should be regularly dusted with a soft cotton or micro-fibre cloth. For more thorough cleaning, occasionally wipe your furniture with a soft cloth dampened with a mild detergent solution. Surfaces should be thoroughly dried with a lint free cloth to prevent watermarks. Under no circumstances should solvent cleaning agents, bleach or abrasive cleaning agents or cloths be used. Glass or mirrored panels should be cleaned using a non-solvent based glass cleaner and a soft cloth. Spills should be removed immediately using a clean cloth. All bathroom furniture will deteriorate through prolonged periods of exposure to high levels of condensation so bathrooms must be adequately ventilated using suitable extraction. Failure to ensure adequate ventilation may invalidate your guarantee.

Installation Guide

Original Fitted Bath End Panel

Important Information

- Read the instructions carefully.
- Ensure product contents are complete.
- Check the product for any signs of damage and remove any protective film.
- It is recommended that a technically competent installer undertakes installation.
- It is the installer's responsibility to carry out a thorough assessment of the wall type and use appropriate fixings.
- Care should be taken when drilling to avoid any hidden wires or pipes.

Installation

Set the height of the bath to suit the height of the bath panel according to the instructions supplied with the bath

Fit the end panel before installing the side panel

Ensure that when the brackets and bath panel are fitted, the panel sits 4mm proud of the bath rim.



Secure one "L" bracket to the wall using suitable fixings. It is recommended that the bracket is fitted 300mm vertically from the underside of the bath.

Secure the second "L" bracket to the underside of the wooden batten under the bath rim using the screws provided.

Screw one of the black Keku clips to the opposite side of the end panel to the wall. The matching Keku clip should be screwed to the back of the front panel. Use the diagram as a guide to how these are fitted.

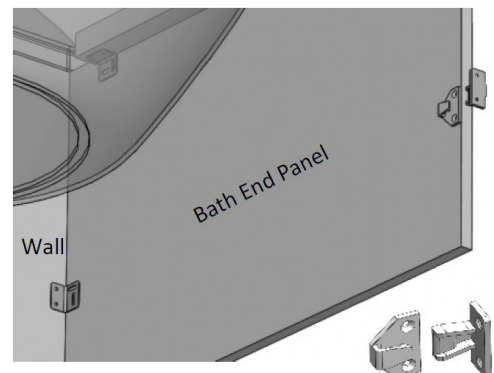

Care & Maintenance

Furniture should be regularly dusted with a soft cotton or micro-fibre cloth. For more thorough cleaning, occasionally wipe your furniture with a soft cloth dampened with a mild detergent solution. Surfaces should be thoroughly dried with a lint free cloth to prevent watermarks. Under no circumstances should solvent cleaning agents, bleach or abrasive cleaning agents or cloths be used. Glass or mirrored panels should be cleaned using a non-solvent based glass cleaner and a soft cloth. Spills should be removed immediately using a clean cloth. All bathroom furniture will deteriorate through prolonged periods of exposure to high levels of condensation so bathrooms must be adequately ventilated using suitable extraction. Failure to ensure adequate ventilation may invalidate your guarantee.

Installation Guide

Original Fitted Double Wall Unit

Important Information

- Read the instructions carefully.
- Check the product for any signs of damage and remove any protective film.
- It is the installer's responsibility to carry out a thorough assessment of wall type and the weight of the cabinet and use appropriate fixings.
- Care should be taken when drilling walls to avoid any hidden wires or pipes.
- To prevent the cabinet falling down this product must be fixed using the wall attachment device provided.

Installation

Mark a horizontal line on the wall at the required height **X---X**. Ensure that the wall brackets will fit inside the width of the cabinet and are equally spaced to ensure even distribution of weight. Secure the wall brackets to the wall using suitable fixings.

Hook the unit onto the wall brackets ensuring that the brackets are securely located.

To alter the position of the cabinet on the wall, adjust the two screws in each hanging bracket. The top screws will move the cabinet closer to or further away from the wall. The lower screws will move the cabinet up and down.

A securing screw should be fitted through the back of the unit through the fixed back of the cabinet and into the wall, this will help to stabilise the unit.

If this cabinet is being fitted in a run, secure the units together with suitable fixings through the gables. Try to hide the fixings where possible behind shelves or hinge plates.

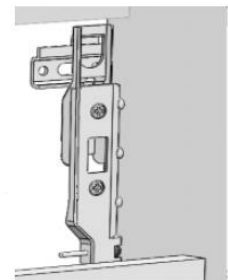
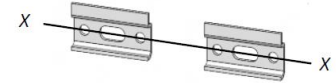

Door Hinge Adjustment

- To square the door against the cabinet, adjust screws A.
- To adjust the door closer to or further away from the cabinet, adjust screws B.
- To adjust the door vertically, slacken screws C. Re-tighten once the door is adjusted as required.
- To remove the door hinges from the cabinet, press button D.
- To remove the door hinges from the door, remove screws E.

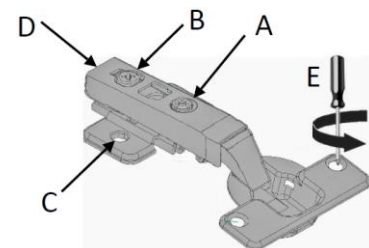

Care & Maintenance

Furniture should be regularly dusted with a soft cotton or micro-fibre cloth. For more thorough cleaning, occasionally wipe your furniture with a soft cloth dampened with a mild detergent solution. Surfaces should be thoroughly dried with a lint free cloth to prevent watermarks. Under no circumstances should solvent cleaning agents, bleach or abrasive cleaning agents or cloths be used. Spills should be removed immediately using a clean cloth. All bathroom furniture will deteriorate through prolonged periods of exposure to high levels of condensation so bathrooms must be adequately ventilated using suitable extraction. Failure to ensure adequate ventilation may invalidate your guarantee.

Installation Guide

Original Fitted Tall Unit

Important Information

- Read the instructions carefully.
- Check the product for any signs of damage and remove any protective film.
- It is recommended that a technically competent installer undertakes installation.
- It is the installer's responsibility to carry out a thorough assessment of the wall type and the weight of the cabinet and use appropriate fixings.
- Care should be taken when drilling walls to avoid any hidden wires or pipes.
- To prevent the cabinet falling down this product must be fixed using the wall attachment device provided.

Installation

Remove the shelf and turn the unit upside down. Push the legs firmly into the leg sockets. Stand the unit on its legs against the wall. Adjust the legs on the units until they are level.

Mark a horizontal line on the wall at the required height **X---X**. Ensure that the wall brackets will fit inside the width of the cabinet and are equally spaced to ensure even distribution of weight. Secure the wall brackets to the wall using suitable fixings.

Hook the unit onto the wall brackets ensuring that the brackets are securely located.

To adjust the position of the cabinet on the wall, use the two screws in each hanging bracket. The top screws will move the cabinet closer to or further away from the wall. The lower screws will move the cabinet up and down.

If this cabinet is being fitted in a run, secure the units together with suitable fixings through the gables. Try to hide the fixings where possible behind shelves or hinge plates.

A securing screw should be fitted through the back of the unit through the fixed back rail of the cabinet and into the wall. This will help to stabilise the unit.

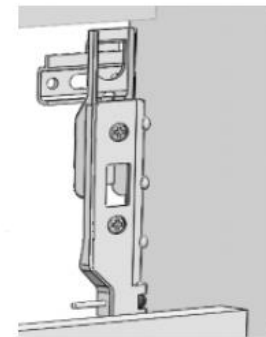
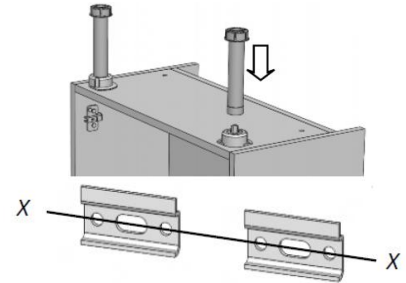

Door Hinge Adjustment

- To square the door against the cabinet, adjust screws A.
- To adjust the door closer to or further away from the cabinet, adjust screws B.
- To adjust the door vertically, slacken screws C. Re-tighten once the door is adjusted as required.
- To remove the door hinges from the cabinet, press button D.
- To remove the door hinges from the door, remove screws E.

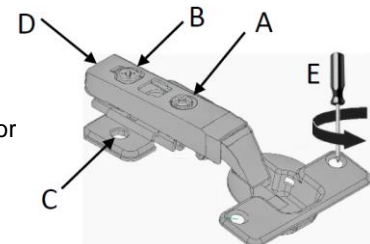

Care & Maintenance

Furniture should be regularly dusted with a soft cotton or micro-fibre cloth. For more thorough cleaning, occasionally wipe your furniture with a soft cloth dampened with a mild detergent solution. Surfaces should be thoroughly dried with a lint free cloth to prevent watermarks. Under no circumstances should solvent cleaning agents, bleach or abrasive cleaning agents or cloths be used. Spills should be removed immediately using a clean cloth. All bathroom furniture will deteriorate through prolonged periods of exposure to high levels of condensation so bathrooms must be adequately ventilated using suitable extraction. Failure to ensure adequate ventilation may invalidate your guarantee.

Installation Guide

Original Fitted Frameless Mirror

Important Information

- Read the instructions carefully.
- Check the product for any signs of damage and remove any protective film.
- It is recommended that a technically competent installer undertakes installation.
- It is the installer's responsibility to carry out a thorough assessment of the wall type and the weight of the product and use appropriate fixings.
- Care should be taken when drilling walls to avoid any hidden wires or pipes.

Installation

Push the plastic inserts into the rear of the mirror panel.

Note: the mirror can be fitted portrait or landscape.

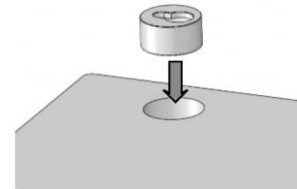

Ensure that the inserts are aligned in the correct direction. Once the inserts have been fitted, they cannot be removed.

Mark the wall to suit the distance between the centres of the inserts.

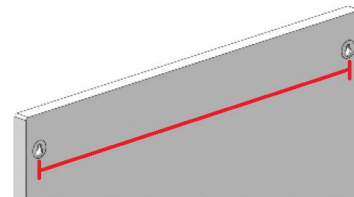

Drill the wall and secure the fixings (not supplied) at the marked positions.

Note: you must ensure that the fixings are suitable for the weight of the mirror and the wall type.

Hang the mirror onto the wall fixings, ensuring that they are located securely into the inserts.

Care & Maintenance

Furniture should be regularly dusted with a soft cotton or micro-fibre cloth. For more thorough cleaning, occasionally wipe your furniture with a soft cloth dampened with a mild detergent solution. Surfaces should be thoroughly dried with a lint free cloth to prevent watermarks. Under no circumstances should solvent cleaning agents, bleach or abrasive cleaning agents or cloths be used. Glass or mirrored panels should be cleaned using a non-solvent based glass cleaner and a soft cloth. Spills should be removed immediately using a clean cloth. All bathroom furniture will deteriorate through prolonged periods of exposure to high levels of condensation so bathrooms must be adequately ventilated using suitable extraction. Failure to ensure adequate ventilation may invalidate your guarantee.

Installation Guide

Laminate Worktop

Important Information

- Read the instructions carefully.
- Check the product for any signs of damage and remove any protective film.
- It is recommended that a technically competent installer undertakes installation.
- Care should be taken when drilling walls to avoid any hidden wires or pipes.
- If this product is to be cut, ensure that the correct Personal Protective Equipment is used and that the room is well ventilated. Any cut edges must be sealed with good quality silicone sealant or PVA glue to prevent water ingress.

Installation

It is recommended that the doors, drawer fronts and fascia panels are removed from the cabinets when fitting a worktop to avoid any potential damage. If the worktop has become slightly bowed due to incorrect storage, it can be pulled straight during the installation process.

Position the worktop on the units and push it up against the wall to enable you to mark and measure for cutting. If the worktop is to be scribed to the wall, do so using a compass and pencil.



We suggest that an allowance of 10mm is made to accommodate a worktop overhang on an exposed worktop or show ends. Use a belt sander to remove the final material and to avoid saw chips. If necessary, hand finish the cut edge using a suitable grade of sandpaper.

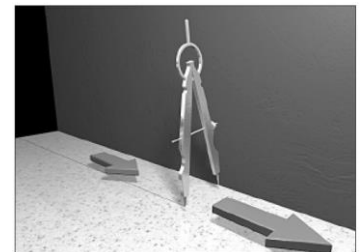

Secure the worktop to the units from underneath using screws of the correct length (not supplied). Stretcher plates (not supplied) can also be used if required.

If the worktop is to be cut to install a semi-recessed basin, use the template supplied with the basin as a guide.

To finish, run a bead of silicone between the joint of the worktop and the wall. Allow 24 hours to allow the silicone to cure fully.



Care & Maintenance

Furniture should be regularly dusted with a soft cotton or micro-fibre cloth. For more thorough cleaning, occasionally wipe your furniture with a soft cloth dampened with a mild detergent solution. Surfaces should be thoroughly dried with a lint free cloth to prevent watermarks. Under no circumstances should solvent cleaning agents, bleach or abrasive cleaning agents or cloths be used. Spills should be removed immediately using a clean cloth. All bathroom furniture will deteriorate through prolonged periods of exposure to high levels of condensation so bathrooms must be adequately ventilated using suitable extraction. Failure to ensure adequate ventilation may invalidate your guarantee.

Installation Guide

Original Fitted Open Shelf Base Unit

Important Information

- Read the instructions carefully.
- Check the product for any signs of damage and remove any protective film.
- It is recommended that a technically competent installer undertakes installation.
- It is the installer's responsibility to carry out a thorough assessment of the wall type and the weight of the cabinet and use appropriate fixings.
- Care should be taken when drilling walls to avoid any hidden wires or pipes.

Installation

Remove the shelf and turn the unit upside down. Push the legs firmly into the leg sockets.

Stand the unit on its legs against the wall. Adjust the legs on the units until they are level.

Secure the unit to the wall by drilling through the back rail and using suitable fixings for the wall type.

If this cabinet is being fitted in a run, secure the units together with suitable fixings through the gables. Try to hide the fixings where possible behind shelves or hinge plates.

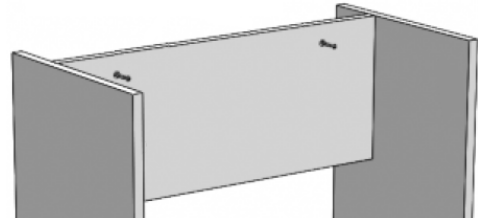
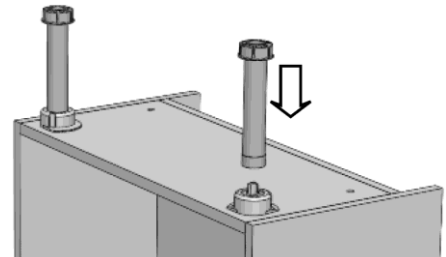

Care & Maintenance

Furniture should be regularly dusted with a soft cotton or micro-fibre cloth. For more thorough cleaning, occasionally wipe your furniture with a soft cloth dampened with a mild detergent solution. Surfaces should be thoroughly dried with a lint free cloth to prevent watermarks. Under no circumstances should solvent cleaning agents, bleach or abrasive cleaning agents or cloths be used. Spills should be removed immediately using a clean cloth. All bathroom furniture will deteriorate through prolonged periods of exposure to high levels of condensation so bathrooms must be adequately ventilated using suitable extraction. Failure to ensure adequate ventilation may invalidate your guarantee.

Installation Guide

Original Fitted Back-To-Wall Toilet Unit

Important Information

- Read the instructions carefully.
- Check the product for any signs of damage and remove any protective film.
- It is recommended that a technically competent installer undertakes installation.
- It is the installer's responsibility to carry out a thorough assessment of the wall type and the weight of the cabinet and use appropriate fixings.
- Care should be taken when drilling walls to avoid any hidden wires or pipes.

Installation

Remove the top fascia panel first by pulling it away from the cabinet with equal force on each side. Turn the unit upside down. Push the legs firmly into the leg sockets.

To secure the WC unit against the wall, screw the stretcher plates to the gable panels of the cabinet as shown in the diagram. Ensure that the screws used are suitable for the thickness of the cabinet.

Mark the position of the holes in the stretcher plates on the wall with a pencil. Drill the positions marked with a suitable drill bit.

Fasten the unit in position through the stretcher plates using fixings suitable for the wall type.

If fitting a run of units, fix them together through the gable panels. Where possible, try to hide the fixings behind shelves or hinge plates.

To cut the lower fascia panel to accommodate the soil pipe and cistern flush pipe, use a jigsaw with a fine-toothed blade suitable for timber. Ensure that the room is well ventilated when cutting the material.

All cut edges must be sealed with PVA glue or good-quality, sanitary grade silicone sealant to prevent the ingress of moisture.

Fit the top fascia panel last, after plumbing connections have been made and installation completed.

Care & Maintenance

Furniture should be regularly dusted with a soft cotton or micro-fibre cloth. For more thorough cleaning, occasionally wipe your furniture with a soft cloth dampened with a mild detergent solution. Surfaces should be thoroughly dried with a lint free cloth to prevent watermarks. Under no circumstances should solvent cleaning agents, bleach or abrasive cleaning agents or cloths be used. Spills should be removed immediately using a clean cloth. All bathroom furniture will deteriorate through prolonged periods of exposure to high levels of condensation so bathrooms must be adequately ventilated using suitable extraction. Failure to ensure adequate ventilation may invalidate your guarantee.

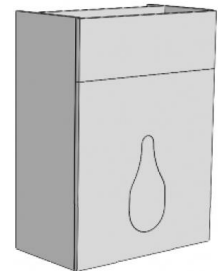
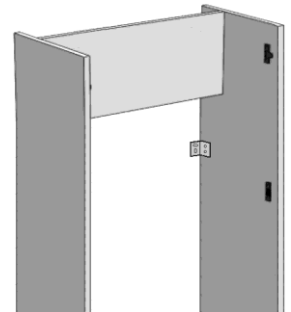
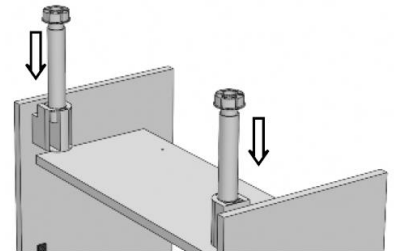

Installation Guide

Original Fitted Drawer Line Unit

Important Information

- Read the instructions carefully.
- Check the product for any signs of damage and remove any protective film.
- It is recommended that a technically competent installer undertakes installation.
- It is the installer's responsibility to carry out a thorough assessment of the wall type and the weight of the cabinet and use appropriate fixings.
- Care should be taken when drilling walls to avoid any hidden wires or pipes.
- If the fascia is to be cut, use a saw with a fine-toothed blade ensuring that the room is well ventilated. Any cut edges should be sealed with PVA glue or silicone sealant to prevent the ingress of moisture.

Installation

Remove the shelf, turn the unit upside down and push the legs firmly into the leg sockets.

Stand the unit back on its legs against the wall. If fitting a run of units, fix them together through the gable panels. Where possible, try to hide the fixings behind shelves or hinge plates.

Adjust the legs on the units until they are level.

Secure the unit to the wall by drilling through the back rail and using suitable fixings for the wall type.

Drawer Front Adjustment

To replace the drawer box, pull the runners out. Sit the drawer box onto the runners. Close the drawer and a click will be heard as the drawer box engages.

To adjust the drawer front left to right, use a screwdriver to rotate the screw in the side towards the front of the drawer box.

To raise or lower the drawer front, use a screwdriver to rotate the screw in the side towards the rear of the drawer box.

Care & Maintenance

Furniture should be regularly dusted with a soft cotton or micro-fibre cloth. For more thorough cleaning, occasionally wipe your furniture with a soft cloth dampened with a mild detergent solution. Surfaces should be thoroughly dried with a lint free cloth to prevent watermarks. Under no circumstances should solvent cleaning agents, bleach or abrasive cleaning agents or cloths be used. Spills should be removed immediately using a clean cloth. Glass or mirrored panels should be cleaned using a non-solvent based glass cleaner and a soft cloth. All bathroom furniture will deteriorate through prolonged periods of exposure to high levels of condensation so bathrooms must be adequately ventilated using suitable extraction. Failure to ensure adequate ventilation may invalidate your guarantee.

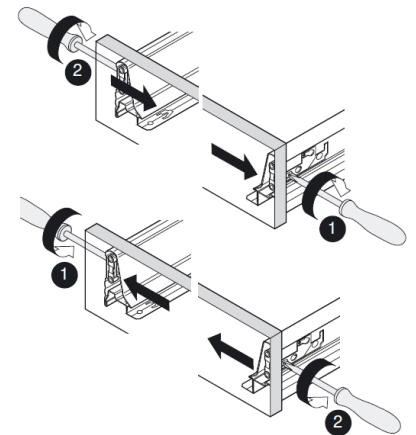
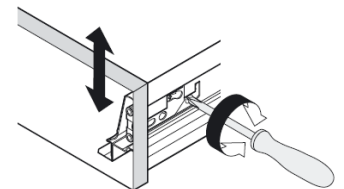
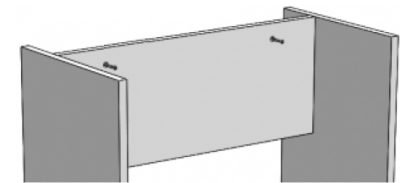
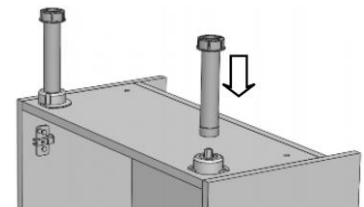

Installation Guide

Original Fitted Bath Head Panel Unit

Important Information

- Read the instructions carefully.
- Check the product for any signs of damage and remove any protective film.
- It is recommended that a technically competent installer undertakes installation.
- It is the installer's responsibility to carry out a thorough assessment of the wall type and the weight of the cabinet and use appropriate fixings.
- Care should be taken when drilling walls to avoid any hidden wires or pipes.

Installation

Remove the top fascia panel first by pulling it away from the cabinet with equal force on each side, then remove the lower fascia panel.

Turn the unit upside down. Push the legs firmly into the leg sockets.

Stand the unit on its legs against the wall. Adjust the legs on the units until they are level.

Secure the unit to the wall by drilling through the back rail and using suitable fixings for the wall type.

If the unit is to be fitted pulled forward so that it is in line with a run of furniture, secure it in position by screwing into the adjacent cabinet and wall through the gable panels. Try to hide the fixings where possible behind shelves or hinge plates.

Re-fit the lower fascia panel first, followed by the top fascia panel.

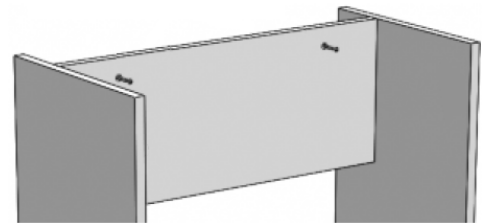
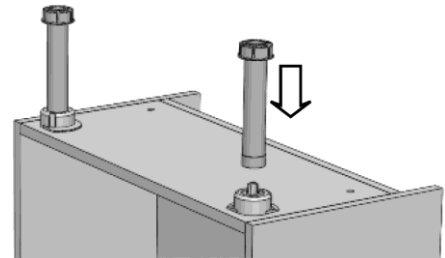

Care & Maintenance

Furniture should be regularly dusted with a soft cotton or micro-fibre cloth. For more thorough cleaning, occasionally wipe your furniture with a soft cloth dampened with a mild detergent solution. Surfaces should be thoroughly dried with a lint free cloth to prevent watermarks. Under no circumstances should solvent cleaning agents, bleach or abrasive cleaning agents or cloths be used. Spills should be removed immediately using a clean cloth. All bathroom furniture will deteriorate through prolonged periods of exposure to high levels of condensation so bathrooms must be adequately ventilated using suitable extraction. Failure to ensure adequate ventilation may invalidate your guarantee.