

# Installation Guide

## Opula 800mm Vanity Unit

### Important Information

- Read the instructions carefully.
- Check the product for any signs of damage and remove any protective film.
- It is recommended that this product is fitted by a suitably qualified Part P registered electrician in accordance with current IET & Building Regulations.
- It is the installer's responsibility to carry out a thorough assessment of wall type and the weight of the cabinet and use appropriate fixings.
- Care should be taken when drilling walls to avoid any hidden wires or pipes.
- To prevent the cabinet falling down this product must be fixed using the wall attachment device provided.
- The light source in this luminaire is not replaceable. When the light source reaches its end of life, the whole luminaire must be replaced.
- This product should be used only with a mains supply that is protected by a 30mA Residual Current Device.
- This product is IP20 Rated and is only suitable for installation in Outside Zones in a bathroom. It is not suitable to be fitted in zones 0, 1 or 2.



### WARNING RISK OF ELECTRIC SHOCK

Turn off Mains Electric prior to commencing work.

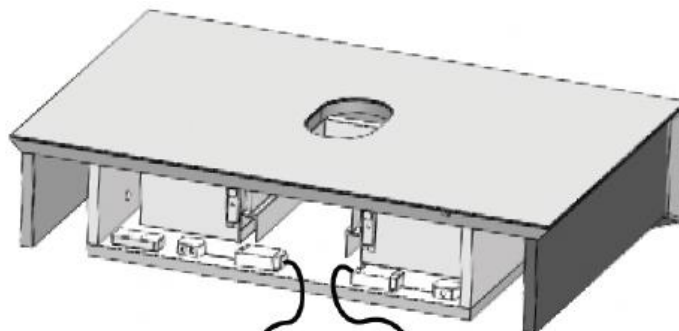
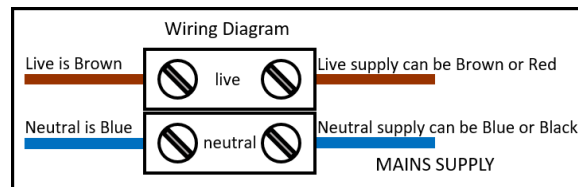

Mains lead out for LED  
Drawer Lights  
Recommend that this is  
wired to a constant feed

Mains lead for under cabinet  
lighting  
Recommend feed is from  
room lights or room sensor

### Connection to Mains Electrics

Turn off the electrical supply.

Connect the mains lead from the drawer lights to the electrical supply in the bathroom. It is recommended that this lead is connected to a constant electrical feed.

Connect the mains lead from the under-cabinet lights to the electrical supply in the bathroom. It is recommended that this lead is connected to the bathroom light circuit or a room sensor.

Turn the electrical supply back on and check that the lights function as required.

### Fitting Unit to Wall

Remove the drawer fronts from the unit. Fully open the drawer, close it 10cm and lift it clear of the runners.

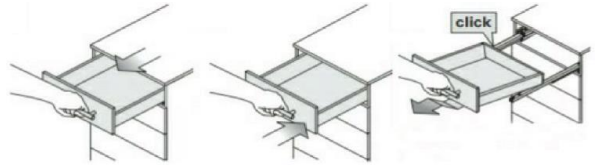

Fix the hanging brackets to the wall at the width shown. Ensure that they are secured using fixings suitable for the wall type and the weight of the unit.

Level the brackets by inserting washers between the bracket(s) and the wall.

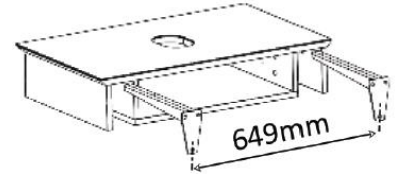

Slide the unit onto the hanging brackets and secure from underneath with suitable screws. Ensure all fixing holes are used.

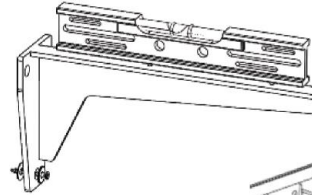

Place the basin onto the worktop. Do not drag the basin as this will scratch the finish.

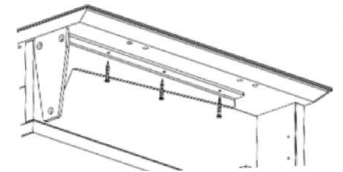

### Fitting Drawer Front

To re-fit the drawer front, engage the tag on the drawer clip into the drawer sides. Tilt the drawer front forwards and push the drawer front into the drawer box sides.

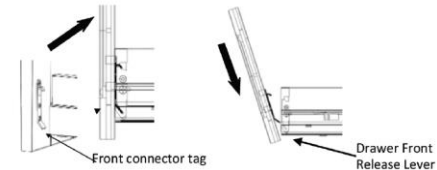

### Drawer adjustment

Horizontal adjustment – press the lever beneath the drawer box side and move the drawer front horizontally as required.

Vertical adjustment – slacken screw 1 and adjust the height as required by turning screw 2.

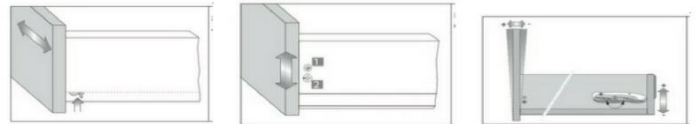

Tilt adjustment – turn the screw on the inside of the drawer box sides, toward the rear of the box

### Care & Maintenance

Furniture should be regularly dusted with a soft cotton or micro-fibre cloth. For more thorough cleaning, occasionally wipe your furniture with a soft cloth dampened with a mild detergent solution. Surfaces should be thoroughly dried with a lint free cloth to prevent watermarks. Under no circumstances should solvent cleaning agents, bleach or abrasive cleaning agents or cloths be used. Spills should be removed immediately using a clean cloth. Glass or mirrored panels should be cleaned using a non-solvent based glass cleaner and a soft cloth. All bathroom furniture will deteriorate through prolonged periods of exposure to high levels of condensation so bathrooms must be adequately ventilated using suitable extraction. Failure to ensure adequate ventilation may invalidate your guarantee.

# Installation Guide

## Opula 1200mm Vanity Unit

### Important Information

- Read the instructions carefully.
- Check the product for any signs of damage and remove any protective film.
- It is recommended that this product is fitted by a suitably qualified Part P registered electrician in accordance with current IET & Building Regulations.
- It is the installer's responsibility to carry out a thorough assessment of wall type and the weight of the cabinet and use appropriate fixings.
- Care should be taken when drilling walls to avoid any hidden wires or pipes.
- To prevent the cabinet falling down this product must be fixed using the wall attachment device provided.
- The light source in this luminaire is not replaceable. When the light source reaches its end of life, the whole luminaire must be replaced.
- This product should be used only with a mains supply that is protected by a 30mA Residual Current Device.
- This product is IP20 Rated and is only suitable for installation in Outside Zones in a bathroom. It is not suitable to be fitted in zones 0, 1 or 2.



### WARNING RISK OF ELECTRIC SHOCK

Turn off Mains Electric prior to commencing work.

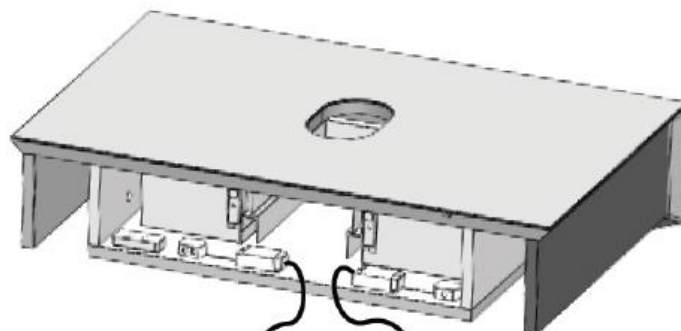
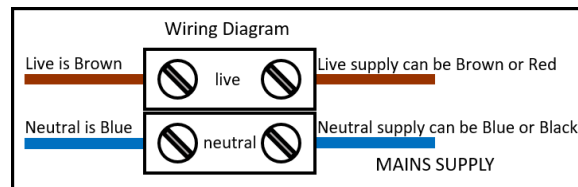

Mains lead out for LED  
Drawer Lights  
Recommend that this is  
wired to a constant feed

Mains lead for under cabinet  
lighting  
Recommend feed is from  
room lights or room sensor

### Connection to Mains Electrics

Turn off the electrical supply.

Connect the mains lead from the drawer lights to the electrical supply in the bathroom. It is recommended that this lead is connected to a constant electrical feed.

Connect the mains lead from the under-cabinet lights to the electrical supply in the bathroom. It is recommended that this lead is connected to the bathroom light circuit or a room sensor.

Turn the electrical supply back on and check that the lights function as required.

## Fitting Unit to Wall

Remove the drawer fronts from the unit. Fully open the drawer, close it 10cm and lift it clear of the runners.

Fix the hanging brackets to the wall at the width shown. Ensure that they are secured using fixings suitable for the wall type and the weight of the unit.

Level the brackets by inserting washers between the bracket(s) and the wall.

Slide the unit onto the hanging brackets and secure from underneath with suitable screws. Ensure all fixing holes are used.

Place the basin onto the worktop. Do not drag the basin as this will scratch the finish.

## Fitting Drawer Front

To re-fit the drawer front, engage the tag on the drawer clip into the drawer sides. Tilt the drawer front forwards and push the drawer front into the drawer box sides.

## Drawer adjustment

Horizontal adjustment – press the lever beneath the drawer box side and move the drawer front horizontally as required.

Vertical adjustment – slacken screw 1 and adjust the height as required by turning screw 2.

Tilt adjustment – turn the screw on the inside of the drawer box sides, toward the rear of the box

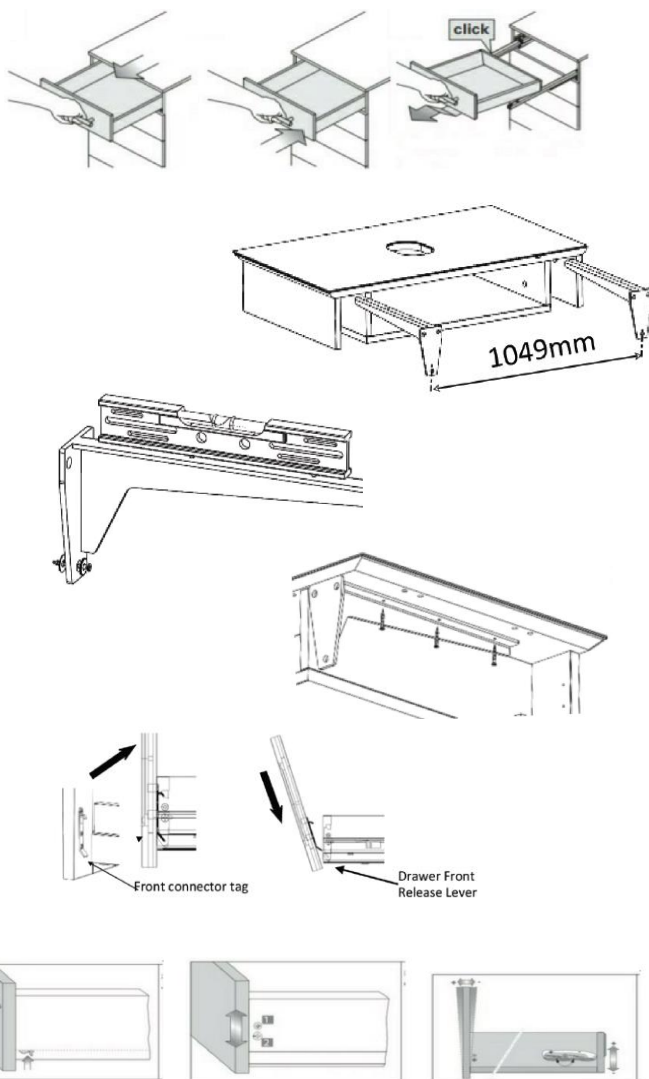

## Care & Maintenance

Furniture should be regularly dusted with a soft cotton or micro-fibre cloth. For more thorough cleaning, occasionally wipe your furniture with a soft cloth dampened with a mild detergent solution. Surfaces should be thoroughly dried with a lint free cloth to prevent watermarks. Under no circumstances should solvent cleaning agents, bleach or abrasive cleaning agents or cloths be used. Spills should be removed immediately using a clean cloth. Glass or mirrored panels should be cleaned using a non-solvent based glass cleaner and a soft cloth. All bathroom furniture will deteriorate through prolonged periods of exposure to high levels of condensation so bathrooms must be adequately ventilated using suitable extraction. Failure to ensure adequate ventilation may invalidate your guarantee.

# Installation Guide

## Opula 1600mm Vanity Unit

### Important Information

- Read the instructions carefully.
- Check the product for any signs of damage and remove any protective film.
- It is recommended that this product is fitted by a suitably qualified Part P registered electrician in accordance with current IET & Building Regulations.
- It is the installer's responsibility to carry out a thorough assessment of wall type and the weight of the cabinet and use appropriate fixings.
- Care should be taken when drilling walls to avoid any hidden wires or pipes.
- To prevent the cabinet falling down this product must be fixed using the wall attachment device provided.
- The light source in this luminaire is not replaceable. When the light source reaches its end of life, the whole luminaire must be replaced.
- This product should be used only with a mains supply that is protected by a 30mA Residual Current Device.
- This product is IP20 Rated and is only suitable for installation in Outside Zones in a bathroom. It is not suitable to be fitted in zones 0, 1 or 2.



### WARNING RISK OF ELECTRIC SHOCK

Turn off Mains Electric prior to commencing work.

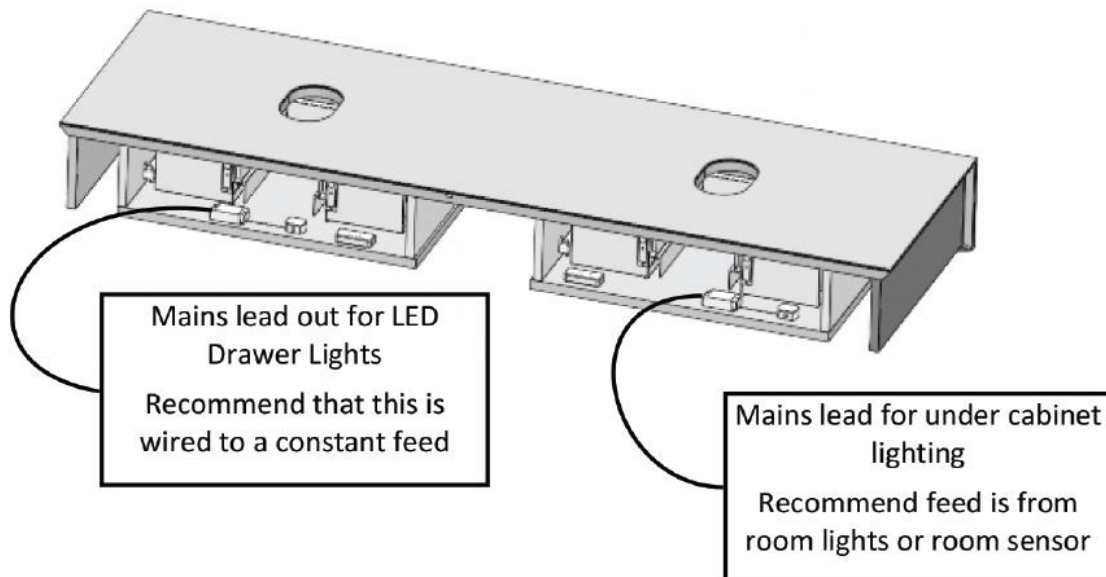
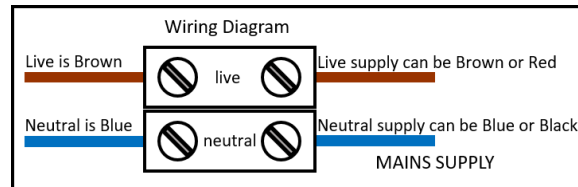

### Connection to Mains Electrics

Turn off the electrical supply.

Connect the mains lead from the drawer lights to the electrical supply in the bathroom. It is recommended that this lead is connected to a constant electrical feed.

Connect the mains lead from the under-cabinet lights to the electrical supply in the bathroom. It is recommended that this lead is connected to the bathroom light circuit or a room sensor.

Turn the electrical supply back on and check that the lights function as required.

### Fitting Unit to Wall

Remove the drawer fronts from the unit. Fully open the drawer, close it 10cm and lift it clear of the runners.

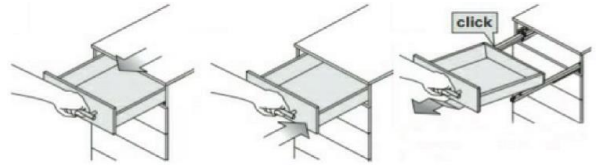

Fix the hanging brackets to the wall at the width shown. Ensure that they are secured using fixings suitable for the wall type and the weight of the unit.

Level the brackets by inserting washers between the bracket(s) and the wall.

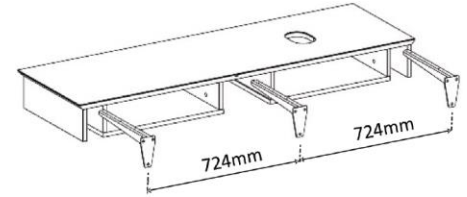

Slide the unit onto the hanging brackets and secure from underneath with suitable screws. Ensure all fixing holes are used.

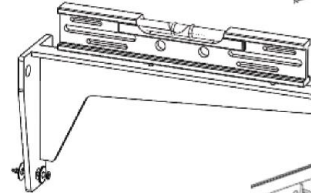

Place the basin onto the worktop. Do not drag the basin as this will scratch the finish.

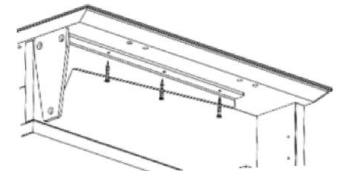

### Fitting Drawer Front

To re-fit the drawer front, engage the tag on the drawer clip into the drawer sides. Tilt the drawer front forwards and push the drawer front into the drawer box sides.

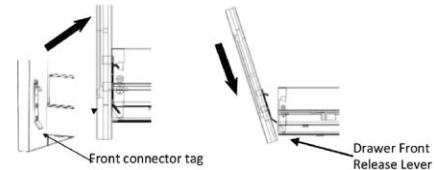

### Drawer adjustment

Horizontal adjustment – press the lever beneath the drawer box side and move the drawer front horizontally as required.

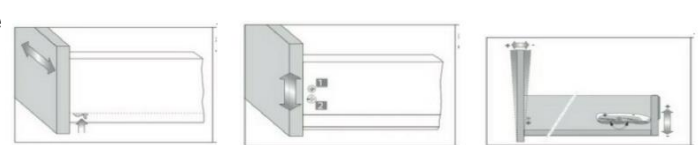

Vertical adjustment – slacken screw 1 and adjust the height as required by turning screw 2.

Tilt adjustment – turn the screw on the inside of the drawer box sides, toward the rear of the box

### Care & Maintenance

Furniture should be regularly dusted with a soft cotton or micro-fibre cloth. For more thorough cleaning, occasionally wipe your furniture with a soft cloth dampened with a mild detergent solution. Surfaces should be thoroughly dried with a lint free cloth to prevent watermarks. Under no circumstances should solvent cleaning agents, bleach or abrasive cleaning agents or cloths be used. Spills should be removed immediately using a clean cloth. Glass or mirrored panels should be cleaned using a non-solvent based glass cleaner and a soft cloth. All bathroom furniture will deteriorate through prolonged periods of exposure to high levels of condensation so bathrooms must be adequately ventilated using suitable extraction. Failure to ensure adequate ventilation may invalidate your guarantee.

# Installation Guide

## Opula Toilet Unit Without Cistern

### Important Information

- Read the instructions carefully.
- Check the product for any signs of damage and remove any protective film.
- It is recommended that a technically competent installer undertakes installation.
- It is the installer's responsibility to carry out a thorough assessment of the wall type and the weight of the cabinet and use appropriate fixings.
- Care should be taken when drilling walls to avoid any hidden wires or pipes.

### Installation

To fit a concealed cistern into the WC unit, pull the front top fascia away from the cabinet. The lower front panel can now be lifted upwards away from the cabinet. Secure the cistern in position according to the instructions supplied with it.

To secure the WC unit against the wall, screw the stretcher plates to the gable panels of the cabinet as shown in the diagram. Ensure that the screws used are suitable for the thickness of the cabinet.

Mark the position of the holes in the stretcher plates on the wall with a pencil. Drill the positions marked with a suitable drill bit.

Fasten the unit in position through the stretcher plates using fixings suitable for the wall type.

To cut the lower fascia panel to accommodate the soil pipe and cistern flush pipe, use a jigsaw with a fine-toothed blade suitable for timber. Ensure that the room is well ventilated when cutting the material.

All cut edges must be sealed with PVA glue or good-quality, sanitary grade silicone sealant to prevent the ingress of moisture.

### Care & Maintenance

Furniture should be regularly dusted with a soft cotton or micro-fibre cloth. For more thorough cleaning, occasionally wipe your furniture with a soft cloth dampened with a mild detergent solution. Surfaces should be thoroughly dried with a lint free cloth to prevent watermarks. Under no circumstances should solvent cleaning agents, bleach or abrasive cleaning agents or cloths be used. Spills should be removed immediately using a clean cloth. All bathroom furniture will deteriorate through prolonged periods of exposure to high levels of condensation so bathrooms must be adequately ventilated using suitable extraction. Failure to ensure adequate ventilation may invalidate your guarantee.

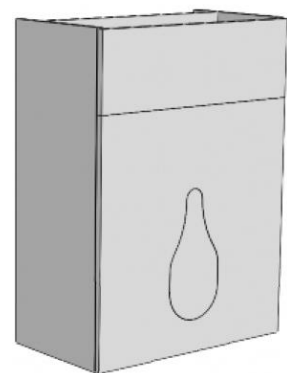
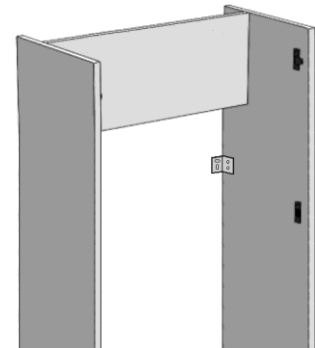
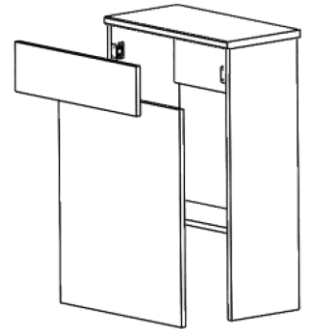

# Installation Guide

## Opula Toilet Unit With Cistern

### Important Information

- Read the instructions carefully.
- Check the product for any signs of damage and remove any protective film.
- It is recommended that a technically competent installer undertakes installation.
- It is the installer's responsibility to carry out a thorough assessment of the wall type and the weight of the cabinet and use appropriate fixings.
- Care should be taken when drilling walls to avoid any hidden wires or pipes.

### Installation

To secure the WC unit against the wall, screw the stretcher plates to the gable panels of the cabinet as shown in the diagram. Ensure that the screws used are suitable for the thickness of the cabinet.

Mark the position of the holes in the stretcher plates on the wall with a pencil. Drill the positions marked with a suitable drill bit.

Fasten the unit in position through the stretcher plates using fixings suitable for the wall type.

To cut the lower fascia panel to accommodate the soil pipe and cistern flush pipe, use a jigsaw with a fine-toothed blade suitable for timber. Ensure that the room is well ventilated when cutting the material.

All cut edges must be sealed with PVA glue or good-quality, sanitary grade silicone sealant to prevent the ingress of moisture.

### Care & Maintenance

Furniture should be regularly dusted with a soft cotton or micro-fibre cloth. For more thorough cleaning, occasionally wipe your furniture with a soft cloth dampened with a mild detergent solution. Surfaces should be thoroughly dried with a lint free cloth to prevent watermarks. Under no circumstances should solvent cleaning agents, bleach or abrasive cleaning agents or cloths be used. Spills should be removed immediately using a clean cloth. All bathroom furniture will deteriorate through prolonged periods of exposure to high levels of condensation so bathrooms must be adequately ventilated using suitable extraction. Failure to ensure adequate ventilation may invalidate your guarantee.

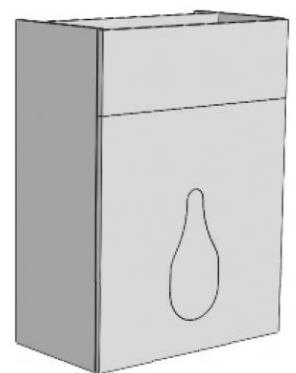
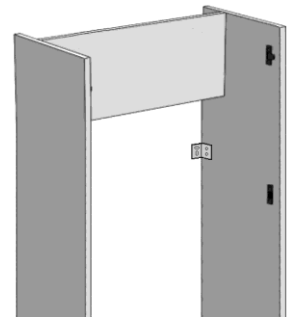
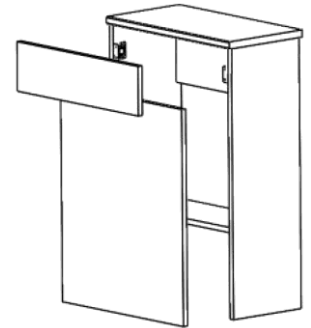



# Installation Guide

## Opula Tall Mirror Cabinet

### Important Information

- Read the instructions carefully.
- Check the product for any signs of damage and remove any protective film.
- It is recommended that this product is fitted by a suitably qualified Part P registered electrician in accordance with current IET & Building Regulations.
- It is the installer's responsibility to carry out a thorough assessment of wall type and the weight of the cabinet and use appropriate fixings.
- Care should be taken when drilling walls to avoid any hidden wires or pipes.
- To prevent the cabinet falling down this product must be fixed using the wall attachment device provided.
- The light source in this luminaire is not replaceable. When the light source reaches its end of life, the whole luminaire must be replaced.
- This product should be used only with a mains supply that is protected by a 30mA Residual Current Device.
- This product is IP20 Rated and is only suitable for installation in Outside Zones in a bathroom. It is not suitable to be fitted in zones 0, 1 or 2.

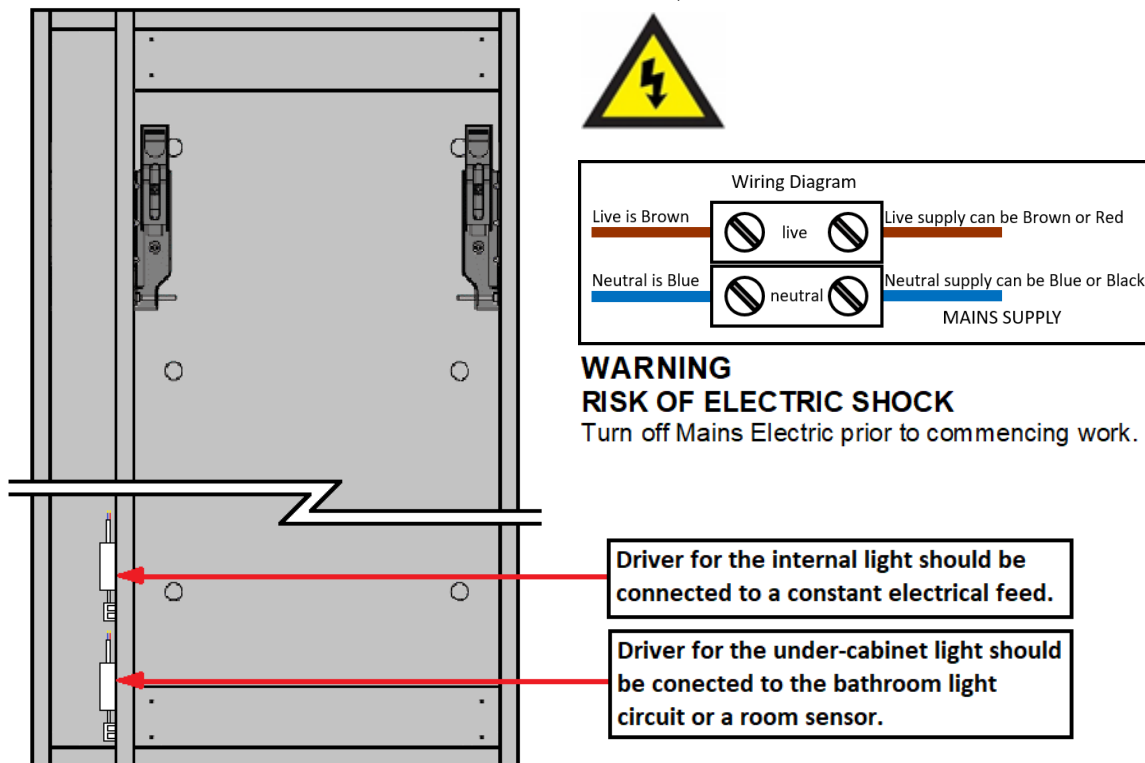

### Connection to Mains Electrics

Turn off the electrical supply.

The drivers and leads to connect the cabinet lighting to the electrical supply in the bathroom is in the side section at the rear of the unit. Connect the mains lead from the internal light driver to the electrical supply in the bathroom. It is recommended that this lead is connected to a constant electrical feed.

Connect the mains lead from the under-cabinet light driver to the electrical supply in the bathroom. It is recommended that this lead is connected to the bathroom light circuit or a room sensor.

Turn the electrical supply back on and check that the lights function as required.

## Fitting Cabinet to Wall

It may be necessary to snap the wall plate in half at the marked line to create two wall brackets. Mark a horizontal line on the wall at the required height X---X. Ensure that the wall brackets will fit inside the width of the cabinet and are equally spaced to ensure even distribution of weight. Secure the wall brackets to the wall using suitable fixings.

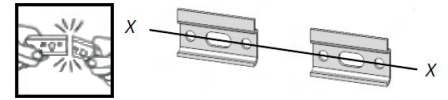

Hook the unit onto the wall brackets ensuring that the brackets are securely located.

To adjust the position of the cabinet on the wall, use the two screws in each hanging bracket. The top screws will move the cabinet closer to or further away from the wall. The lower screws will move the cabinet up and down.

A securing screw should be fitted through the back of the unit through the fixed back rail of the cabinet and into the wall. This will help to stabilise the unit.

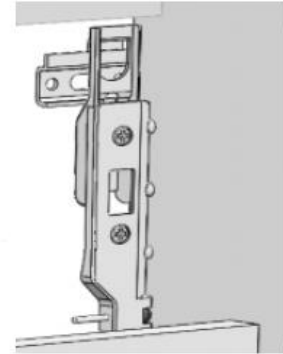

## Fitting Doors

To fit the doors, remove the door hinges from the cabinet by pressing button D.

Lay the door face down and push the door hinges into the pre-drilled holes. Secure them in place by tightening screws E.

To re-fit the door hinges, push the hinge arm onto the mounting plate from the front. Push the rear of the hinge arm onto the plate until a click is heard.

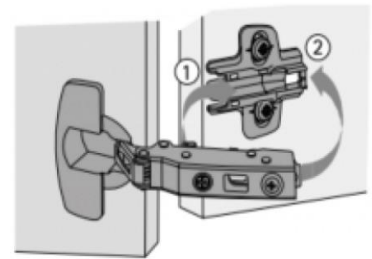

## Door hinge adjustment

To square the door against the cabinet, turn screws A until adjusted as required.

To adjust the door closer to or further away from the cabinet, turn screws B.

To adjust the door vertically, slacken screws C. Re-tighten once the door is adjusted as required.

To remove the door hinges from the cabinet, press button D.

To remove the door hinges from the door, remove screws E.

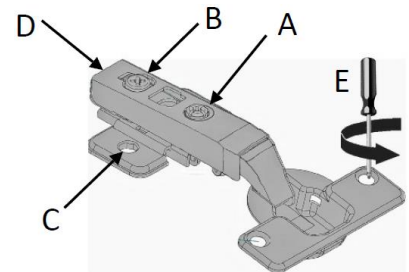

## Care & Maintenance

Furniture should be regularly dusted with a soft cotton or micro-fibre cloth. For more thorough cleaning, occasionally wipe your furniture with a soft cloth dampened with a mild detergent solution. Surfaces should be thoroughly dried with a lint free cloth to prevent watermarks. Under no circumstances should solvent cleaning agents, bleach or abrasive cleaning agents or cloths be used. Spills should be removed immediately using a clean cloth. All bathroom furniture will deteriorate through prolonged periods of exposure to high levels of condensation so bathrooms must be adequately ventilated using suitable extraction. Failure to ensure adequate ventilation may invalidate your guarantee.

# Installation Guide

## Opula Bath Side Panel

### Important Information

- Read the instructions carefully.
- Ensure product contents are complete.
- Check the product for any signs of damage and remove all protective film.
- It is recommended that a technically competent installer undertakes installation.
- It is the installer's responsibility to carry out a thorough assessment of the installation environment (i.e. wall type/structure) and use appropriate fixings.
- Care should be taken when drilling to avoid any hidden wires or pipes.
- If the panel is required to be trimmed, a fine-toothed saw should be used. Ensure that the room is well ventilated and that any cut edges are sealed with PVA glue or silicone sealant to prevent water ingress.

### Installation

Set the height of the bath to suit the height of the bath panel according to the instructions supplied with the bath. Ensure that when the brackets and bath panel are fitted, the panel sits 4mm proud of the bath rim.

If you are installing this side panel in conjunction with an end panel, fit the end panel first according to the instructions supplied with it.

Screw three black Keku clips to the underside of the wooden batten underneath the bath rim using the screws provided. The three clips should be equally spaced along the length of the bath. Use the diagram as a guide to how the Keku clips are fitted.

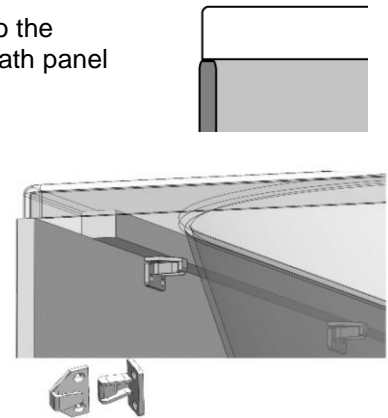

The matching Keku clips should be screwed to the rear of the bath panel using the screws supplied. Measure carefully to ensure that the clips on the rear of the bath panel will engage with the clips screwed to the bath.

If the bath panel is being fitted between two walls, the two "L" brackets should be secured to the walls to prevent the panel from being pushed inwards. Ensure suitable fixings are used.

If the bath panel is being used in conjunction with an end panel, secure one "L" bracket to the wall to prevent the panel from being pushed inwards. On the opposite side to the wall secure the bath panel in place using a Keku clip. This Keku clip is supplied with the end panel, along with instruction on how it is fitted.

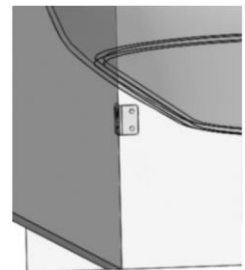

Once fully installed, seal around the bath panel on all joints using a good quality, sanitary-grade silicone sealant.

### Care & Maintenance

Furniture should be regularly dusted with a soft cotton or micro-fibre cloth. For more thorough cleaning, occasionally wipe your furniture with a soft cloth dampened with a mild detergent solution. Surfaces should be thoroughly dried with a lint free cloth to prevent watermarks. Under no circumstances should solvent cleaning agents, bleach or abrasive cleaning agents or cloths be used. Glass or mirrored panels should be cleaned using a non-solvent based glass cleaner and a soft cloth. Spills should be removed immediately using a clean cloth. All bathroom furniture will deteriorate through prolonged periods of exposure to high levels of condensation so bathrooms must be adequately ventilated using suitable extraction. Failure to ensure adequate ventilation may invalidate your guarantee.

# Installation Guide

## Opula Bath End Panel

### Important Information

- Read the instructions carefully.
- Ensure product contents are complete.
- Check the product for any signs of damage and remove all protective film.
- It is recommended that a technically competent installer undertakes installation.
- It is the installer's responsibility to carry out a thorough assessment of the installation environment (i.e. wall type/structure) and use appropriate fixings.
- Care should be taken when drilling to avoid any hidden wires or pipes.
- If the panel is required to be trimmed, a fine-toothed saw should be used. Ensure that the room is well ventilated and that any cut edges are sealed with PVA glue or silicone sealant to prevent water ingress.

### Installation

Set the height of the bath to suit the height of the bath panel according to the instructions supplied with the bath.

Fit the end panel before installing the side panel. The bath end panel sits behind the side panel. The thickness of the bath side panel must be considered when scribing the bath end panel to the wall.

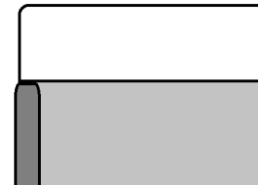

Ensure that when the brackets and bath panel are fitted, the panel sits 4mm proud of the bath rim.

Secure one "L" bracket to the wall using suitable fixings. It is recommended that the bracket is fitted 300mm vertically from the underside of the bath.

Secure the second "L" bracket to the underside of the wooden batten under the bath rim using the screws provided.

Screw one of the black Keku clips to the opposite side of the end panel to the wall. The matching Keku clip should be screwed to the back of the front panel. Use the diagram as a guide to how these are fitted.

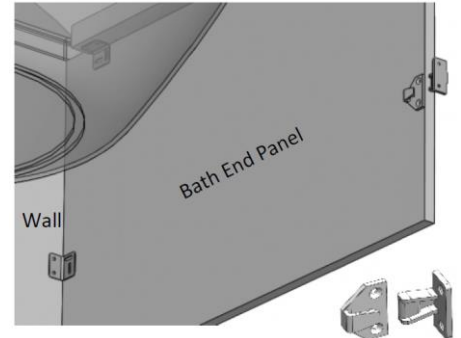

Once fully installed, seal around the bath panel on all joints using a good quality, sanitary-grade silicone sealant.

### Care & Maintenance

Furniture should be regularly dusted with a soft cotton or micro-fibre cloth. For more thorough cleaning, occasionally wipe your furniture with a soft cloth dampened with a mild detergent solution. Surfaces should be thoroughly dried with a lint free cloth to prevent watermarks. Under no circumstances should solvent cleaning agents, bleach or abrasive cleaning agents or cloths be used. Glass or mirrored panels should be cleaned using a non-solvent based glass cleaner and a soft cloth. Spills should be removed immediately using a clean cloth. All bathroom furniture will deteriorate through prolonged periods of exposure to high levels of condensation so bathrooms must be adequately ventilated using suitable extraction. Failure to ensure adequate ventilation may invalidate your guarantee.