

# Installation Guide

## Downton Freestanding Washbasin Unit

### Important Information

- Read the instructions carefully.
- Ensure product contents are complete.
- Check the product for any signs of damage and remove any protective film.
- It is recommended that a technically competent installer undertakes installation.
- It is the installer's responsibility to carry out a thorough assessment of the installation environment (i.e. wall type/structure and the combined weight of the cabinet and basin) and use appropriate fixings.
- Care should be taken when drilling to avoid any hidden wires or pipes.
- If the unit/panels are to be trimmed, a fine-toothed saw should be used. Ensure that the room is well ventilated and that any cut edges are sealed with PVA glue or silicone sealant to prevent water ingress.

### Installation

Secure the unit to the wall by drilling through the back rail and using suitable fixings for the wall type.

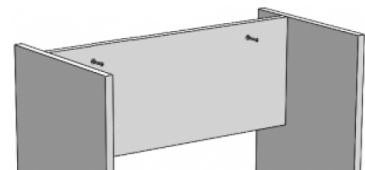

### Infill panel

There is the option to fit a supplied infill panel. This should be secured in place using double-sided tape (not supplied) or fixed in place with screws. Ensure that the length of screw is suitable for the thickness of the infill panel and the cabinet legs.

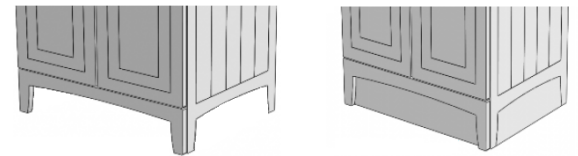

### Door hinge adjustment

- To square the door against the cabinet, turn screws A until adjusted as required.
- To adjust the door closer to or further away from the cabinet, turn screws B.
- To adjust the door vertically, slacken screws C. Re-tighten once the door is adjusted as required.
- To remove the door hinges from the cabinet, press button D.
- To remove the door hinges from the door, remove screws E.

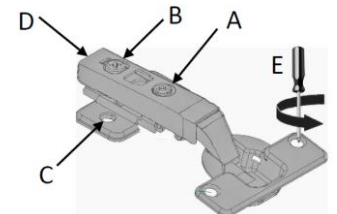

### Care & Maintenance

Furniture should be regularly dusted with a soft cotton or micro-fibre cloth. For more thorough cleaning, occasionally wipe your furniture with a soft cloth dampened with a mild detergent solution. Surfaces should be thoroughly dried with a lint free cloth to prevent watermarks. Under no circumstances should solvent cleaning agents, bleach or abrasive cleaning agents or cloths be used. Spills should be removed immediately using a clean cloth. All bathroom furniture will deteriorate through prolonged periods of exposure to high levels of condensation so bathrooms must be adequately ventilated using suitable extraction. Failure to ensure adequate ventilation may invalidate your guarantee.

# Installation Guide

## Downton Freestanding Undermount Washbasin Unit

### Important Information

- Read the instructions carefully.
- Ensure product contents are complete.
- Check the product for any signs of damage and remove any protective film.
- It is recommended that a technically competent installer undertakes installation.
- It is the installer's responsibility to carry out a thorough assessment of the installation environment (i.e. wall type/structure and the combined weight of the cabinet and basin) and use appropriate fixings.
- Care should be taken when drilling to avoid any hidden wires or pipes.
- If the unit/panels are to be trimmed, a fine-toothed saw should be used. Ensure that the room is well ventilated and that any cut edges are sealed with PVA glue or silicone sealant to prevent water ingress.

### Installation

Secure the unit to the wall by drilling through the back rail and using suitable fixings for the wall type.

When fitting the basin support shelf, ensure that the white side is facing upwards and the small cut-out is to the front of the unit. Loosen the screws in the stretcher brackets. Place the basin onto the support shelf. With a spirit level on the basin, adjust the position of the shelf so that there is a 10mm gap above the gables. Once levelled, retighten the screws and add an extra screw in each stretcher bracket. Apply a bead of silicone to the top face of the basins and the gables before fitting the worktop in position. Allow 24 hours before use for the silicone to fully cure.

### Infill panel

There is the option to fit a supplied infill panel. This should be secured in place using double-sided tape (not supplied) or fixed in place with screws. Ensure that the length of screw is suitable for the thickness of the infill panel and the cabinet legs.

### Care & Maintenance

Furniture should be regularly dusted with a soft cotton or micro-fibre cloth. For more thorough cleaning, occasionally wipe your furniture with a soft cloth dampened with a mild detergent solution. Surfaces should be thoroughly dried with a lint free cloth to prevent watermarks. Under no circumstances should solvent cleaning agents, bleach or abrasive cleaning agents or cloths be used. Spills should be removed immediately using a clean cloth. All bathroom furniture will deteriorate through prolonged periods of exposure to high levels of condensation so bathrooms must be adequately ventilated using suitable extraction. Failure to ensure adequate ventilation may invalidate your guarantee.

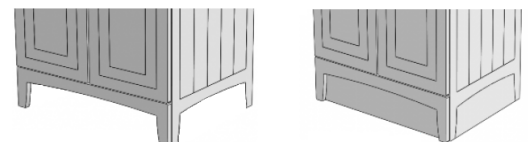
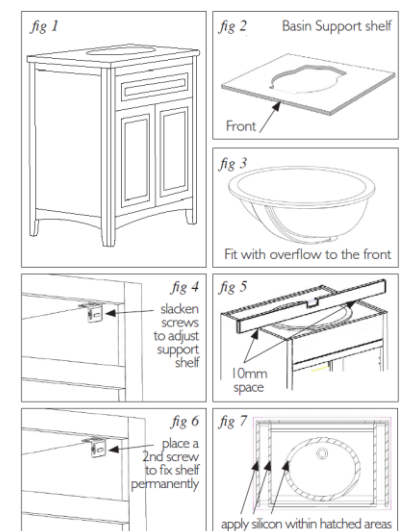
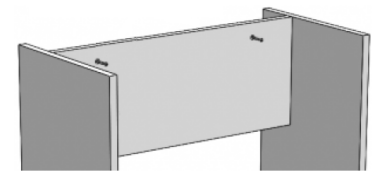

# Installation Guide

## Downton Toilet Unit Without Cistern

### Important Information

- Read the instructions carefully.
- Check the product for any signs of damage and remove any protective film.
- It is recommended that a technically competent installer undertakes installation.
- It is the installer's responsibility to carry out a thorough assessment of the wall type and the weight of the cabinet and use appropriate fixings.
- Care should be taken when drilling walls to avoid any hidden wires or pipes.

### Installation

To fit a concealed cistern into the WC unit, pull the front top fascia away from the cabinet with equal force on each side. The lower front panel can now be lifted upwards away from the cabinet. Secure the cistern in position according to the instructions supplied with it.

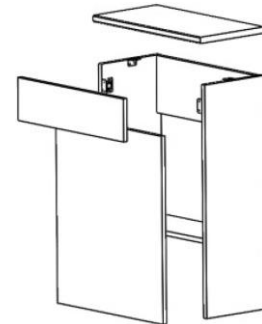

To secure the WC unit against the wall, drill through the rear top rail. Fix the unit in position using suitable fixings.

Re-fit the top fascia panel last, after plumbing connections have been made and installation completed.

### Infill panel

There is the option to fit a supplied infill panel. This should be secured in place using double-sided tape (not supplied) or fixed in place with screws. Ensure that the length of screw is suitable for the thickness of the infill panel and the cabinet legs.

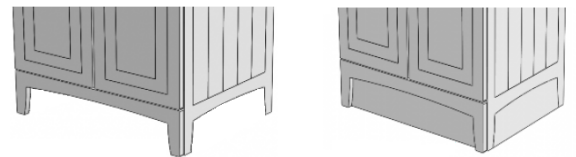

### Care & Maintenance

Furniture should be regularly dusted with a soft cotton or micro-fibre cloth. For more thorough cleaning, occasionally wipe your furniture with a soft cloth dampened with a mild detergent solution. Surfaces should be thoroughly dried with a lint free cloth to prevent watermarks. Under no circumstances should solvent cleaning agents, bleach or abrasive cleaning agents or cloths be used. Glass or mirrored panels should be cleaned using a non-solvent based glass cleaner and a soft cloth. Spills should be removed immediately using a clean cloth. All bathroom furniture will deteriorate through prolonged periods of exposure to high levels of condensation so bathrooms must be adequately ventilated using suitable extraction. Failure to ensure adequate ventilation may invalidate your guarantee.

# Installation Guide

## Downton Toilet Unit With Cistern

### Important Information

- Read the instructions carefully.
- Check the product for any signs of damage and remove any protective film.
- It is recommended that a technically competent installer undertakes installation.
- It is the installer's responsibility to carry out a thorough assessment of the wall type and the weight of the cabinet and use appropriate fixings.
- Care should be taken when drilling walls to avoid any hidden wires or pipes.

### Installation

To secure the WC unit against the wall, remove the top fascia panel first, followed by the lower fascia panel.

Drill through the back top rail and fix the cabinet against the wall using fixings suitable for the wall type.

Re-fit the top fascia panel last, after plumbing connections have been made and installation completed.

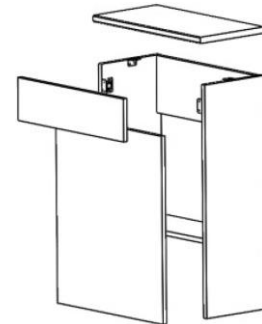

### Infill panel

There is the option to fit a supplied infill panel. This should be secured in place using double-sided tape (not supplied) or fixed in place with screws. Ensure that the length of screw is suitable for the thickness of the infill panel and the cabinet legs.

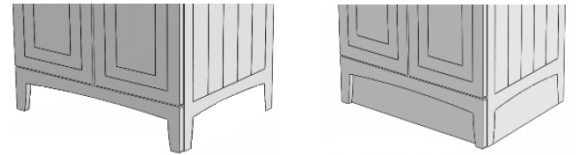

### Care & Maintenance

Furniture should be regularly dusted with a soft cotton or micro-fibre cloth. For more thorough cleaning, occasionally wipe your furniture with a soft cloth dampened with a mild detergent solution. Surfaces should be thoroughly dried with a lint free cloth to prevent watermarks. Under no circumstances should solvent cleaning agents, bleach or abrasive cleaning agents or cloths be used. Glass or mirrored panels should be cleaned using a non-solvent based glass cleaner and a soft cloth. Spills should be removed immediately using a clean cloth. All bathroom furniture will deteriorate through prolonged periods of exposure to high levels of condensation so bathrooms must be adequately ventilated using suitable extraction. Failure to ensure adequate ventilation may invalidate your guarantee.

# Installation Guide

## Downton Tall Single Base Unit

### Important Information

- Read the instructions carefully.
- Check the product for any signs of damage and remove any protective film.
- It is recommended that a technically competent installer undertakes installation.
- It is the installer's responsibility to carry out a thorough assessment of the wall type and the weight of the cabinet and use appropriate fixings.
- Care should be taken when drilling walls to avoid any hidden wires or pipes.

### Installation

To secure the unit against the wall, screw the stretcher plates to the gable panels of the cabinet as shown in the diagram. Ensure that the screws used are suitable for the thickness of the cabinet.

Mark the position of the holes in the stretcher plates on the wall with a pencil. Drill the positions marked with a suitable drill bit.

Fasten the unit in position through the stretcher plates using fixings suitable for the wall type.

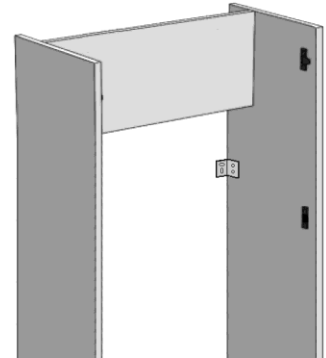

### Infill panel

There is the option to fit a supplied infill panel. This should be secured in place using double-sided tape (not supplied) or fixed in place with screws. Ensure that the length of screw is suitable for the thickness of the infill panel and the cabinet legs.

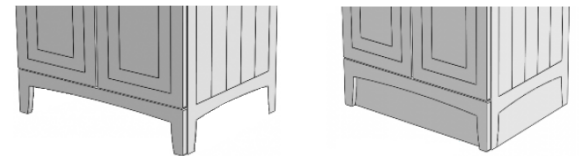

### Door hinge adjustment

- To square the door against the cabinet, turn screws A until adjusted as required.
- To adjust the door closer to or further away from the cabinet, turn screws B.
- To adjust the door vertically, slacken screws C. Re-tighten once the door is adjusted as required.
- To remove the door hinges from the cabinet, press button D.
- To remove the door hinges from the door, remove screws E.

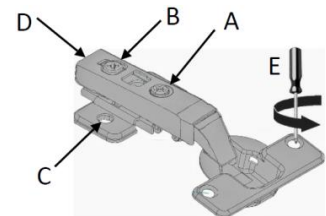

### Care & Maintenance

Furniture should be regularly dusted with a soft cotton or micro-fibre cloth. For more thorough cleaning, occasionally wipe your furniture with a soft cloth dampened with a mild detergent solution. Surfaces should be thoroughly dried with a lint free cloth to prevent watermarks. Under no circumstances should solvent cleaning agents, bleach or abrasive cleaning agents or cloths be used. Spills should be removed immediately using a clean cloth. Some furniture polishes are unsuitable for use on painted surfaces. All bathroom furniture will deteriorate through prolonged periods of exposure to high levels of condensation so bathrooms must be adequately ventilated using suitable extraction. Failure to ensure adequate ventilation may invalidate your guarantee.

# Installation Guide

## Downton Mirror Cabinet



Bathroom Perfection

### Important Information

- Read the instructions carefully.
- Check the product for any signs of damage and remove any protective film.
- It is the installer's responsibility to carry out a thorough assessment of wall type and the weight of the cabinet and use appropriate fixings.
- Care should be taken when drilling walls to avoid any hidden wires or pipes.
- To prevent the cabinet falling down this product must be fixed using the wall attachment device provided.

### Installation

It may be necessary to snap the wall plate in half at the marked line to create two wall brackets. Mark a horizontal line on the wall at the required height X---X. Ensure that the wall brackets will fit inside the width of the cabinet and are equally spaced to ensure even distribution of weight. Secure the wall brackets to the wall using suitable fixings.

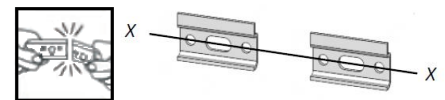

Hook the unit onto the wall brackets ensuring that the brackets are securely located.

To alter the position of the cabinet on the wall, adjust the two screws in each hanging bracket. The top screws will move the cabinet closer to or further away from the wall. The lower screws will move the cabinet up and down.

A securing screw should be fitted through the back of the unit through the fixed back of the cabinet and into the wall, this will help to stabilise the unit.

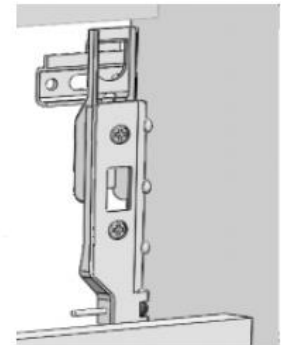

### Door hinge adjustment

- To square the door against the cabinet, adjust screws A.
- To adjust the door closer to or further away from the cabinet, adjust screws B.
- To adjust the door vertically, slacken screws C. Re-tighten once the door is adjusted as required.
- To remove the door hinges from the cabinet, press button D.
- To remove the door from the door hinges, remove screws E.

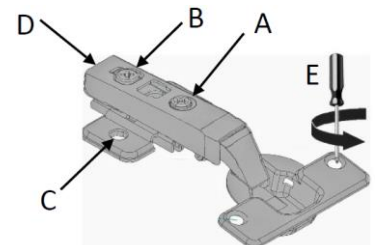

### Care & Maintenance

Furniture should be regularly dusted with a soft cotton or micro-fibre cloth. For more thorough cleaning, occasionally wipe your furniture with a soft cloth dampened with a mild detergent solution. Surfaces should be thoroughly dried with a lint free cloth to prevent watermarks. Under no circumstances should solvent cleaning agents, bleach or abrasive cleaning agents or cloths be used. Glass or mirrored panels should be cleaned using a non-solvent based glass cleaner and a soft cloth. Spills should be removed immediately using a clean cloth. All bathroom furniture will deteriorate through prolonged periods of exposure to high levels of condensation so bathrooms must be adequately ventilated using suitable extraction. Failure to ensure adequate ventilation may invalidate your guarantee.



# Installation Guide

## Downton Illuminated Mirror

### Important Information

- Read the instructions carefully.
- Check the product for any signs of damage and remove any protective film.
- It is recommended that this product is fitted by a suitably qualified Part P registered electrician in accordance with current IEE & Building Regulations.
- It is the installer's responsibility to carry out a thorough assessment of wall type and the weight of the cabinet and use appropriate fixings.
- Care should be taken when drilling walls to avoid any hidden wires or pipes.
- The terminal block used to connect the leads to the electrical supply can be of either the screw- or screw-less type and should be rated at 240V 6A with 4 terminals. The cable tails do not need to be crimped when connected to the terminal block.
- This product should be used only with a mains supply that is protected by a 30mA Residual Current Device.
- This product is IP20 Rated and is only suitable for installation in Outside Zones in a bathroom. It is not suitable to be fitted in zones 0, 1 or 2.

### Connection to Mains Electrics

Warning: risk of electric shock. Turn off the electrical supply prior to commencing work.

Connect the cable connector from the shelf lights into the connector ports on the driver (A).

Connect the electrical supply in the bathroom to the driver cable (B). Turn the electrical supply back on and check that the lights function as required.

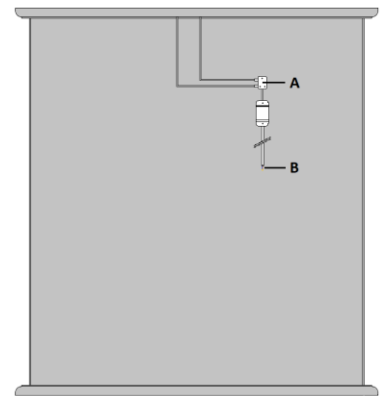

### Fitting Mirror to Wall

It may be necessary to snap the wall plate in half at the marked line to create two wall brackets. Mark a horizontal line on the wall at the required height X---X. Ensure that the wall brackets will fit inside the width of the cabinet and are equally spaced to ensure even distribution of weight. Secure the wall brackets to the wall using suitable fixings.

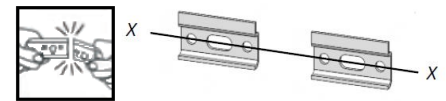

Hook the unit onto the wall brackets ensuring that the brackets are securely located.

To alter the position of the cabinet on the wall, adjust the two screws in each hanging bracket. The top screws will move the cabinet closer to or further away from the wall. The lower screws will move the cabinet up and down.

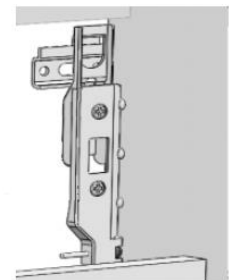

### Care & Maintenance

Furniture should be regularly dusted with a soft cotton or micro-fibre cloth. For more thorough cleaning, occasionally wipe your furniture with a soft cloth dampened with a mild detergent solution. Surfaces should be thoroughly dried with a lint free cloth to prevent watermarks. Under no circumstances should solvent cleaning agents, bleach or abrasive cleaning agents or cloths be used. Glass or mirrored panels should be cleaned using a non-solvent based glass cleaner and a soft cloth. Spills should be removed immediately using a clean cloth. All bathroom furniture will deteriorate through prolonged periods of exposure to high levels of condensation so bathrooms must be adequately ventilated using suitable extraction. Failure to ensure adequate ventilation may invalidate your guarantee.

# Installation Guide

## Downton Framed Mirror

### Important Information

- Read the instructions carefully.
- Check the product for any signs of damage and remove any protective film.
- It is recommended that a technically competent installer undertakes installation.
- It is the installer's responsibility to carry out a thorough assessment of the wall type and the weight of the product and use appropriate fixings.
- Care should be taken when drilling walls to avoid any hidden wires or pipes.

### Installation

Push the plastic inserts into the rear of the mirror panel.

**Note:** the mirror can be fitted portrait or landscape.

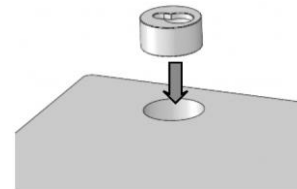

Ensure that the inserts are aligned in the correct direction. Once the inserts have been fitted, they cannot be removed.

Mark the wall to suit the distance between the centres of the inserts.

Drill the wall and secure the fixings (not supplied) at the marked positions.

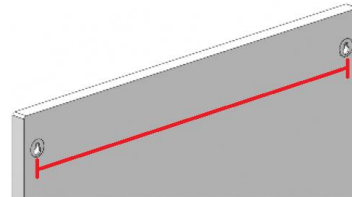

**Note:** you must ensure that the fixings are suitable for the weight of the mirror and the wall type.

Hang the mirror onto the wall fixings, ensuring that they are located securely into the inserts.

### Care & Maintenance

Furniture should be regularly dusted with a soft cotton or micro-fibre cloth. For more thorough cleaning, occasionally wipe your furniture with a soft cloth dampened with a mild detergent solution. Surfaces should be thoroughly dried with a lint free cloth to prevent watermarks. Under no circumstances should solvent cleaning agents, bleach or abrasive cleaning agents or cloths be used. Glass or mirrored panels should be cleaned using a non-solvent based glass cleaner and a soft cloth. Spills should be removed immediately using a clean cloth. All bathroom furniture will deteriorate through prolonged periods of exposure to high levels of condensation so bathrooms must be adequately ventilated using suitable extraction. Failure to ensure adequate ventilation may invalidate your guarantee.



# Installation Guide

## Downton Bath Side Panel

### Important Information

- Read the instructions carefully.
- Ensure product contents are complete.
- Check the product for any signs of damage and remove all protective film.
- It is recommended that a technically competent installer undertakes installation.
- It is the installer's responsibility to carry out a thorough assessment of the installation environment (i.e. wall type/structure) and use appropriate fixings.
- Care should be taken when drilling to avoid any hidden wires or pipes.
- If the panel is required to be trimmed, a fine-toothed saw should be used. Ensure that the room is well ventilated and that any cut edges are sealed with PVA glue or silicone sealant to prevent water ingress.

### Installation

Set the height of the bath to suit the height of the bath panel according to the instructions supplied with the bath. Ensure that when the brackets and bath panel are fitted, the panel sits 4mm proud of the bath rim.

If you are installing this side panel in conjunction with an end panel, fit the end panel first according to the instructions supplied with it.

Screw three black Keku clips to the underside of the wooden batten underneath the bath rim using the screws provided. The three clips should be equally spaced along the length of the bath. Use the diagram as a guide to how the Keku clips are fitted.

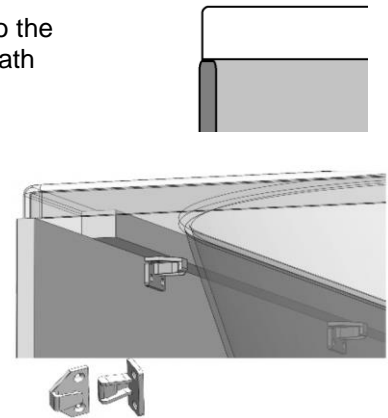

The matching Keku clips should be screwed to the rear of the bath panel using the screws supplied. Measure carefully to ensure that the clips on the rear of the bath panel will engage with the clips screwed to the bath.

If the bath panel is being fitted between two walls, the two "L" brackets should be secured to the walls to prevent the panel from being pushed inwards. Ensure suitable fixings are used.

If the bath panel is being used in conjunction with an end panel, secure one "L" bracket to the wall to prevent the panel from being pushed inwards. On the opposite side to the wall secure the bath panel in place using a Keku clip. This Keku clip is supplied with the end panel, along with instruction on how it is fitted.

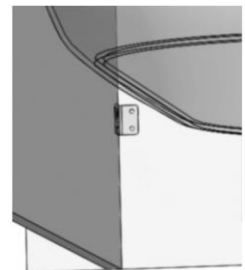

Once fully installed, seal around the bath panel on all joints using a good quality, sanitary-grade silicone sealant.

### Care & Maintenance

Furniture should be regularly dusted with a soft cotton or micro-fibre cloth. For more thorough cleaning, occasionally wipe your furniture with a soft cloth dampened with a mild detergent solution. Surfaces should be thoroughly dried with a lint free cloth to prevent watermarks. Under no circumstances should solvent cleaning agents, bleach or abrasive cleaning agents or cloths be used. Glass or mirrored panels should be cleaned using a non-solvent based glass cleaner and a soft cloth. Spills should be removed immediately using a clean cloth. All bathroom furniture will deteriorate through prolonged periods of exposure to high levels of condensation so bathrooms must be adequately ventilated using suitable extraction. Failure to ensure adequate ventilation may invalidate your guarantee.

# Installation Guide

## Downton Bath End Panel



Bathroom Perfection

### Important Information

- Read the instructions carefully.
- Ensure product contents are complete.
- Check the product for any signs of damage and remove all protective film.
- It is recommended that a technically competent installer undertakes installation.
- It is the installer's responsibility to carry out a thorough assessment of the installation environment (i.e. wall type/structure) and use appropriate fixings.
- Care should be taken when drilling to avoid any hidden wires or pipes.
- If the panel is required to be trimmed, a fine-toothed saw should be used. Ensure that the room is well ventilated and that any cut edges are sealed with PVA glue or silicone sealant to prevent water ingress.

### Installation

Set the height of the bath to suit the height of the bath panel according to the instructions supplied with the bath.

Fit the end panel before installing the side panel. The bath end panel sits behind the side panel. The thickness of the bath side panel must be considered when scribing the bath end panel to the wall.

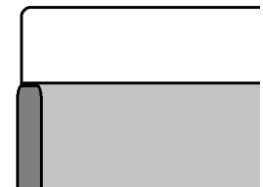

Ensure that when the brackets and bath panel are fitted, the panel sits 4mm proud of the bath rim.

Secure one "L" bracket to the wall using suitable fixings. It is recommended that the bracket is fitted 300mm vertically from the underside of the bath.

Secure the second "L" bracket to the underside of the wooden batten under the bath rim using the screws provided.

Screw one of the black Keku clips to the opposite side of the end panel to the wall. The matching Keku clip should be screwed to the back of the front panel. Use the diagram as a guide to how these are fitted.

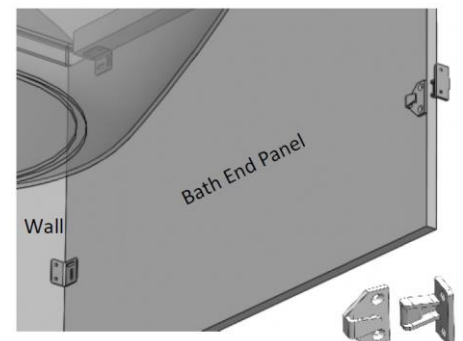

Once fully installed, seal around the bath panel on all joints using a good quality, sanitary-grade silicone sealant.

### Care & Maintenance

Furniture should be regularly dusted with a soft cotton or micro-fibre cloth. For more thorough cleaning, occasionally wipe your furniture with a soft cloth dampened with a mild detergent solution. Surfaces should be thoroughly dried with a lint free cloth to prevent watermarks. Under no circumstances should solvent cleaning agents, bleach or abrasive cleaning agents or cloths be used. Glass or mirrored panels should be cleaned using a non-solvent based glass cleaner and a soft cloth. Spills should be removed immediately using a clean cloth. All bathroom furniture will deteriorate through prolonged periods of exposure to high levels of condensation so bathrooms must be adequately ventilated using suitable extraction. Failure to ensure adequate ventilation may invalidate your guarantee.