

Installation Guide

Contemporary Fitted Washbasin Door Unit

Important Information

- Read the instructions carefully.
- Check the product for any signs of damage and remove any protective film.
- It is recommended that a technically competent installer undertakes installation.
- It is the installer's responsibility to carry out a thorough assessment of the wall type and the weight of the cabinet and use appropriate fixings.
- Care should be taken when drilling walls to avoid any hidden wires or pipes.
- If the fascia is to be cut, use a saw with a fine-toothed blade ensuring that the room is well ventilated. Any cut edges should be sealed with PVA glue or silicone sealant to prevent the ingress of moisture.

Installation

Remove the doors, fascia panel and shelf and turn the unit upside down. Push the legs firmly into the leg sockets. Stand the unit back on its legs against the wall.

Adjust the legs so that there is 100mm from the bottom of the gable to the floor. Ensure that the run of units is level.

Secure the units to the wall by drilling through the back rail and using fixings suitable for the wall type.

If this cabinet is being fitted in a run, secure the units together with suitable fixings through the gables. Try to hide the fixings where possible behind shelves or hinge plates.

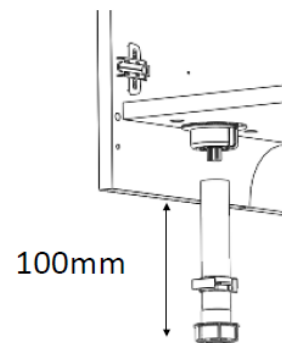

Door hinge adjustment

- To square the door against the cabinet, turn screws A until adjusted as required.
- To adjust the door closer to or further away from the cabinet, turn screws B.
- To adjust the door vertically, slacken screws C. Re-tighten once the door is adjusted as required.
- To remove the door hinges from the cabinet, press button D.
- To remove the door hinges from the door, remove screws E.

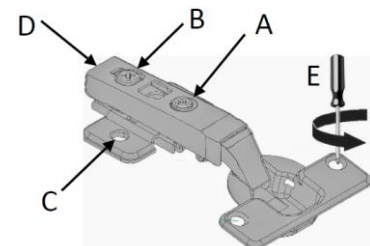

Installing Metal Trim

- Cut the metal trim to the required length to suit the run of units.
- Place the trim over the fixing clips on the gable panels.
- Insert the T bolt and turn it 90°.
- Slide the T bolt to the end of the trim to lock it in position.

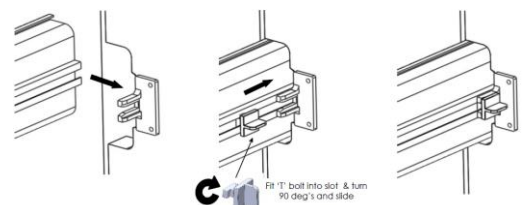

Care & Maintenance

Furniture should be regularly dusted with a soft cotton or micro-fibre cloth. For more thorough cleaning, occasionally wipe your furniture with a soft cloth dampened with a mild detergent solution. Surfaces should be thoroughly dried with a lint free cloth to prevent watermarks. Under no circumstances should solvent cleaning agents, bleach or abrasive cleaning agents or cloths be used. Spills should be removed immediately using a clean cloth. Glass or mirrored panels should be cleaned using a non-solvent based glass cleaner and a soft cloth. All bathroom furniture will deteriorate through prolonged periods of exposure to high levels of condensation so bathrooms must be adequately ventilated using suitable extraction. Failure to ensure adequate ventilation may invalidate your guarantee.

Installation Guide

Contemporary Fitted Washbasin Drawer Unit

Important Information

- Read the instructions carefully.
- Check the product for any signs of damage and remove any protective film.
- It is recommended that a technically competent installer undertakes installation.
- It is the installer's responsibility to carry out a thorough assessment of the wall type and the weight of the cabinet and use appropriate fixings.
- Care should be taken when drilling walls to avoid any hidden wires or pipes.
- If the fascia is to be cut, use a saw with a fine-toothed blade ensuring that the room is well ventilated. Any cut edges should be sealed with PVA glue or silicone sealant to prevent the ingress of moisture.

Installation

Remove the doors, fascia panel and shelf and turn the unit upside down. Push the legs firmly into the leg sockets. Stand the unit back on its legs against the wall.

Adjust the legs so that there is 100mm from the bottom of the gable to the floor. Ensure that the run of units is level. Secure the units to the wall by drilling through the back rail and using fixings suitable for the wall type.

If this cabinet is being fitted in a run, secure the units together with suitable fixings through the gables. Try to hide the fixings where possible behind shelves or hinge plates.

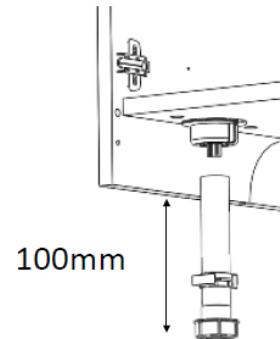

Drawer Box Removal and Replacement

To remove the drawer box, pull the drawer fully out and lift it upwards. To re-fit the drawer box, pull the runners fully out, place the drawer box on the runners and push it rearwards until it clicks into place.



Drawer Front Removal

Slide the drawer side covers rearwards to expose the screws. Using a crosshead screwdriver, turn the screws shown to release the drawer front. Where there are two screws on each drawer side, turn the top screw first followed by the bottom one.



Drawer Front Adjustment

Slide the drawer side covers rearwards to expose the adjustment screws. To raise or lower the drawer front, turn the larger screws with a crosshead screwdriver until adjusted as required. To move the drawer front from side to side, turn the smaller screws. To adjust the tilt of the drawer front, remove the caps from the tops of the drawer sides. Use a cross-head screwdriver to adjust as required.

Installing Metal Trim

- Cut the metal trim to the required length to suit the run of units.
- Place the trim over the fixing clips on the gable panels.
- Insert the T bolt and turn it 90°.
- Slide the T bolt to the end of the trim to lock it in position.

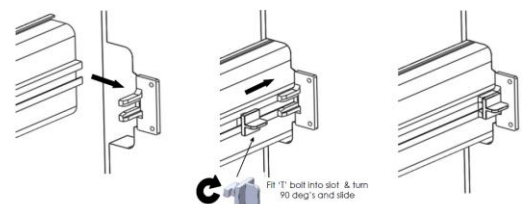

Care & Maintenance

Furniture should be regularly dusted with a soft cotton or micro-fibre cloth. For more thorough cleaning, occasionally wipe your furniture with a soft cloth dampened with a mild detergent solution. Surfaces should be thoroughly dried with a lint free cloth to prevent watermarks. Under no circumstances should solvent cleaning agents, bleach or abrasive cleaning agents or cloths be used. Spills should be removed immediately using a clean cloth. Glass or mirrored panels should be cleaned using a non-solvent based glass cleaner and a soft cloth. All bathroom furniture will deteriorate through prolonged periods of exposure to high levels of condensation so bathrooms must be adequately ventilated using suitable extraction. Failure to ensure adequate ventilation may invalidate your guarantee.

Installation Guide

Contemporary Fitted Wall Mounted Drawer Unit

Important Information

- Read the instructions carefully.
- Check the product for any signs of damage and remove any protective film.
- It is recommended that a technically competent installer undertakes installation.
- It is the installer's responsibility to carry out a thorough assessment of the wall type and the weight of the cabinet and use appropriate fixings.
- Care should be taken when drilling walls to avoid any hidden wires or pipes.
- If the fascia is to be cut, use a saw with a fine-toothed blade ensuring that the room is well ventilated. Any cut edges should be sealed with PVA glue or silicone sealant to prevent the ingress of moisture.

Installation

Mark a horizontal line on the wall at the required height. Ensure that the wall brackets will fit inside the width of the cabinet and are equally spaced to ensure even distribution of weight. Secure the wall brackets to the wall using suitable fixings.

Hook the unit onto the wall brackets so that the spring locks the arm into place.

To alter the position of the cabinet on the wall, adjust the two screws in each hanging bracket. Adjusting screws A will move the cabinet up and down. When the cabinet is level on the wall, screws B will tighten the cabinet to the wall.

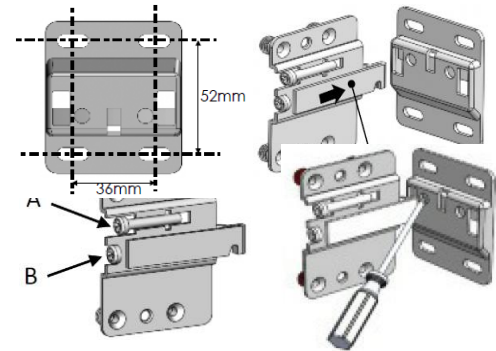

Drawer Box Removal and Replacement

To remove the drawer box, pull the drawer fully out and lift it upwards. To re-fit the drawer box, pull the runners fully out, place the drawer box on the runners and push it rearwards until it clicks into place.



Drawer Front Removal

Slide the slide the drawer side covers rearwards to expose the screws. Using a crosshead screwdriver, turn the screws shown to release the drawer front. Where there are two screws on each drawer side, turn the top screw first followed by the bottom one.

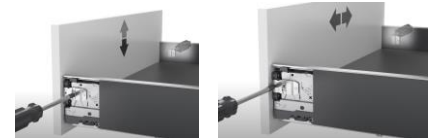

Drawer Front Adjustment

Slide the drawer side covers rearwards to expose the adjustment screws. To raise or lower the drawer front, turn the larger screws with a crosshead screwdriver until adjusted as required. To move the drawer front from side to side, turn the smaller screws. To adjust the tilt of the drawer front, remove the caps from the tops of the drawer sides. Use a cross-head screwdriver to adjust as required.



Fitting Metal Trim

Insert the T bolt and turn it 90°. Slide the T bolt to the end of the trim to lock it in position.

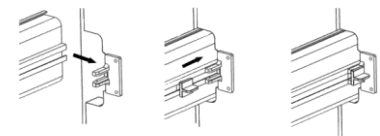

Care & Maintenance

Furniture should be regularly dusted with a soft cotton or micro-fibre cloth. For more thorough cleaning, occasionally wipe your furniture with a soft cloth dampened with a mild detergent solution. Surfaces should be thoroughly dried with a lint free cloth to prevent watermarks. Under no circumstances should solvent cleaning agents, bleach or abrasive cleaning agents or cloths be used. Spills should be removed immediately using a clean cloth. Glass or mirrored panels should be cleaned using a non-solvent based glass cleaner and a soft cloth. All bathroom furniture will deteriorate through prolonged periods of exposure to high levels of condensation so bathrooms must be adequately ventilated using suitable extraction. Failure to ensure adequate ventilation may invalidate your guarantee.

Installation Guide

Contemporary Fitted Back-To-Wall Toilet Unit

Important Information

- Read the instructions carefully.
- Check the product for any signs of damage and remove any protective film.
- It is recommended that a technically competent installer undertakes installation.
- It is the installer's responsibility to carry out a thorough assessment of the wall type and the weight of the cabinet and use appropriate fixings.
- Care should be taken when drilling walls to avoid any hidden wires or pipes.

Installation

Remove the fascia panels, turn the unit upside down and push the legs firmly into the leg sockets.

Adjust the legs so that the cabinet is level and there is 100mm from the bottom of the gables to the floor.

To secure the WC unit against the wall, drill through the back top rail. Fix the cabinet against the wall using fixings suitable for the wall type.

If fitting a run of units, fix them together through the gable panels. Where possible, try to hide the fixings behind shelves or hinge plates.

To cut the lower fascia panel to accommodate the soil pipe and cistern flush pipe, use a jigsaw with a fine-toothed blade suitable for timber. Ensure that the room is well ventilated when cutting the material.

All cut edges must be sealed with PVA glue or good-quality, sanitary grade silicone sealant to prevent the ingress of moisture.

Installing Metal Trim

- Cut the metal trim to the required length.
- Place the trim over the fixing clips on the gable panels.
- Insert the T bolt and turn it 90°.
- Slide the T bolt to the end of the trim to lock it in position.

Care & Maintenance

Furniture should be regularly dusted with a soft cotton or micro-fibre cloth. For more thorough cleaning, occasionally wipe your furniture with a soft cloth dampened with a mild detergent solution. Surfaces should be thoroughly dried with a lint free cloth to prevent watermarks. Under no circumstances should solvent cleaning agents, bleach or abrasive cleaning agents or cloths be used. Spills should be removed immediately using a clean cloth. Glass or mirrored panels should be cleaned using a non-solvent based glass cleaner and a soft cloth. All bathroom furniture will deteriorate through prolonged periods of exposure to high levels of condensation so bathrooms must be adequately ventilated using suitable extraction. Failure to ensure adequate ventilation may invalidate your guarantee.

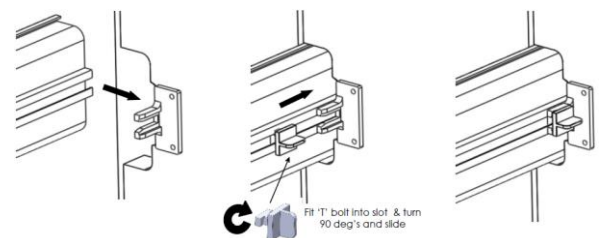
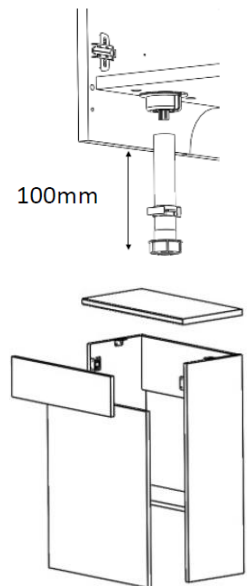

Installation Guide

Contemporary Fitted Back-To-Wall Toilet Unit With Cladding Panel

Important Information

- Read the instructions carefully.
- Check the product for any signs of damage and remove any protective film.
- It is recommended that a technically competent installer undertakes installation.
- It is the installer's responsibility to carry out a thorough assessment of the wall type and the weight of the cabinet and use appropriate fixings.
- Care should be taken when drilling walls to avoid any hidden wires or pipes.

Installation

Remove the fascia panels, turn the unit upside down and push the legs firmly into the leg sockets.

Adjust the legs so that the cabinet is level and there is 100mm from the bottom of the gables to the floor.

To secure the WC unit against the wall, drill through the back top rail. Fix the cabinet against the wall using fixings suitable for the wall type.

If fitting a run of units, fix them together through the gable panels. Where possible, try to hide the fixings behind shelves or hinge plates.

Install cladding panels either side of the unit to hide the carcasses. If fitting a cut-back WC unit against a wall, fit a reduced cladding panel flush with the front of the fascia and set the infill panel back by 20mm (both shown shaded in grey).

To cut the lower fascia panel to accommodate the soil pipe and cistern flush pipe use a jigsaw with a fine-toothed blade suitable for timber. Ensure that the room is well ventilated when cutting the material.

All cut edges must be sealed with PVA glue or good-quality, sanitary grade silicone sealant to prevent the ingress of moisture.

Installing Metal Trim

Cut the metal trim to the required length. Place the trim over the fixing clips on the gable panels. Insert the T bolt and turn it 90°. Slide the T bolt to the end of the trim to lock it in position.

Care & Maintenance

Furniture should be regularly dusted with a soft cotton or micro-fibre cloth. For more thorough cleaning, occasionally wipe your furniture with a soft cloth dampened with a mild detergent solution. Surfaces should be thoroughly dried with a lint free cloth to prevent watermarks. Under no circumstances should solvent cleaning agents, bleach or abrasive cleaning agents or cloths be used. Spills should be removed immediately using a clean cloth. Glass or mirrored panels should be cleaned using a non-solvent based glass cleaner and a soft cloth. All bathroom furniture will deteriorate through prolonged periods of exposure to high levels of condensation so bathrooms must be adequately ventilated using suitable extraction. Failure to ensure adequate ventilation may invalidate your guarantee.

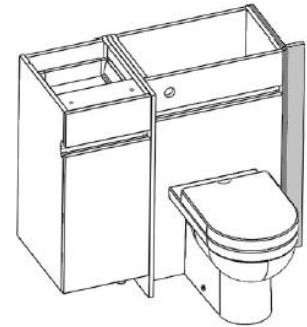

Fit cladding Panels fitted either side of WC unit

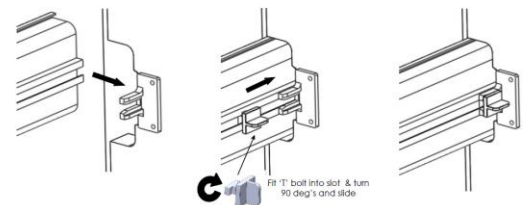
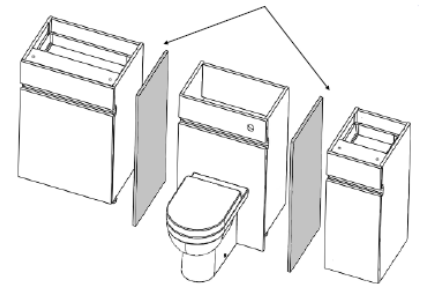

Fit T bolt into slot & turn 90 deg's and slide

Installation Guide

Contemporary Fitted Tissue Roll Unit

Important Information

- Read the instructions carefully.
- Check the product for any signs of damage and remove any protective film.
- It is recommended that a technically competent installer undertakes installation.
- It is the installer's responsibility to carry out a thorough assessment of the wall type and the weight of the cabinet and use appropriate fixings.
- Care should be taken when drilling walls to avoid any hidden wires or pipes.

Installation

Turn the unit upside down and push the legs firmly into the leg sockets.

Stand the unit back on its legs against the wall. If fitting a run of units, fix them together through the gable panels. Where possible, try to hide the fixings behind shelves or hinge plates.

Adjust the legs so that there is 100mm from the bottom of the gable to the floor. Ensure that the run of units is level.

Secure the unit to the wall by drilling through the back rail and using suitable fixings for the wall type.

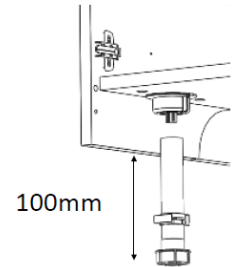

Drawer Box Removal and Replacement

To remove the drawer box, pull the drawer fully out and lift it upwards. To re-fit the drawer box, pull the runners fully out, place the drawer box on the runners and push it rearwards until it clicks into place.



Drawer Front Removal

Slide the drawer side covers rearwards to expose the screws. Using a crosshead screwdriver, turn the screws shown to release the drawer front. Where there are two screws on each drawer side, turn the top screw first followed by the bottom one.

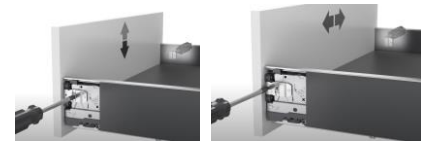

Drawer Front Adjustment

Slide the drawer side covers rearwards to expose the adjustment screws. To raise or lower the drawer front, turn the larger screws with a crosshead screwdriver until adjusted as required. To move the drawer front from side to side, turn the smaller screws. To adjust the tilt of the drawer front, remove the caps from the tops of the drawer sides. Use a cross-head screwdriver to adjust as required.



Installing Metal Trim

- Cut the metal trim to the required length to suit the run of units.
- Place the trim over the fixing clips on the gable panels.
- Insert the T bolt and turn it 90°.
- Slide the T bolt to the end of the trim to lock it in position.

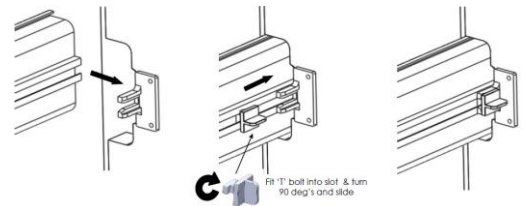

Care & Maintenance

Furniture should be regularly dusted with a soft cotton or micro-fibre cloth. For more thorough cleaning, occasionally wipe your furniture with a soft cloth dampened with a mild detergent solution. Surfaces should be thoroughly dried with a lint free cloth to prevent watermarks. Under no circumstances should solvent cleaning agents, bleach or abrasive cleaning agents or cloths be used. Spills should be removed immediately using a clean cloth. All bathroom furniture will deteriorate through prolonged periods of exposure to high levels of condensation so bathrooms must be adequately ventilated using suitable extraction. Failure to ensure adequate ventilation may invalidate your guarantee.

Installation Guide

Contemporary Fitted Single Base Door Unit

Utopia

Bathroom Perfection

Important Information

- Read the instructions carefully.
- Check the product for any signs of damage and remove any protective film.
- It is recommended that a technically competent installer undertakes installation.
- It is the installer's responsibility to carry out a thorough assessment of the wall type and the weight of the cabinet and use appropriate fixings.
- Care should be taken when drilling walls to avoid any hidden wires or pipes.

Installation

Remove the shelf, turn the unit upside down and push the legs firmly into the leg sockets.

Stand the unit back on its legs against the wall. Adjust the legs so that it is level and there is 100mm from bottom of the gable to the floor.

If fitting a run of units, fix them together through the gable panels. Where possible, try to hide the fixings behind shelves or hinge plates.

To secure the unit against the wall, drill through the rear top rail. Fix the unit in position using suitable fixings.

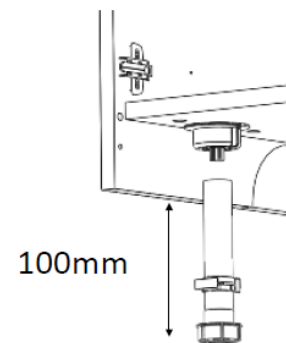

Door hinge adjustment

- To square the door against the cabinet, turn screws A until adjusted as required.
- To adjust the door closer to or further away from the cabinet, turn screws B.
- To adjust the door vertically, slacken screws C. Re-tighten once the door is adjusted as required.
- To remove the door hinges from the cabinet, press button D.
- To remove the door hinges from the door, remove screws E.

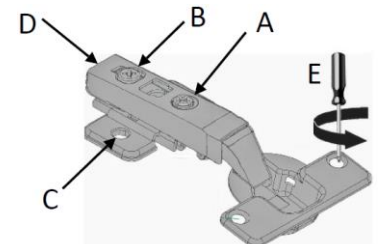

Installing metal trim.

- Cut the metal trim to the required length.
- Place the trim over the fixing clips on the gable panels.
- Insert the T bolt and turn it 90°.
- Slide the T bolt to the end of the trim to lock it in position.

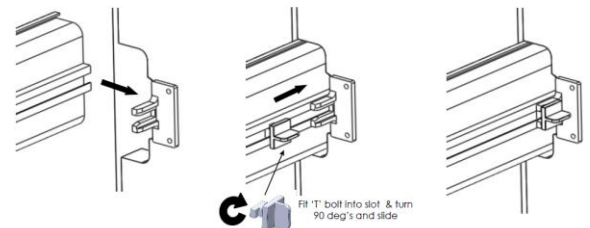

Care & Maintenance

Furniture should be regularly dusted with a soft cotton or micro-fibre cloth. For more thorough cleaning, occasionally wipe your furniture with a soft cloth dampened with a mild detergent solution. Surfaces should be thoroughly dried with a lint free cloth to prevent watermarks. Under no circumstances should solvent cleaning agents, bleach or abrasive cleaning agents or cloths be used. Spills should be removed immediately using a clean cloth. Glass or mirrored panels should be cleaned using a non-solvent based glass cleaner and a soft cloth. All bathroom furniture will deteriorate through prolonged periods of exposure to high levels of condensation so bathrooms must be adequately ventilated using suitable extraction. Failure to ensure adequate ventilation may invalidate your guarantee.

Installation Guide

Contemporary Fitted Single Base Drawer Unit

Utopia

Bathroom Perfection

Important Information

- Read the instructions carefully.
- Check the product for any signs of damage and remove any protective film.
- It is recommended that a technically competent installer undertakes installation.
- It is the installer's responsibility to carry out a thorough assessment of the wall type and the weight of the cabinet and use appropriate fixings.
- Care should be taken when drilling walls to avoid any hidden wires or pipes.

Installation

Remove the shelf, turn the unit upside down and push the legs firmly into the leg sockets.

Stand the unit back on its legs against the wall. Adjust the legs so that it is level and there is 100mm from bottom of the gable to the floor.

If fitting a run of units, fix them together through the gable panels. Where possible, try to hide the fixings behind shelves or hinge plates.

To secure the unit against the wall, drill through the rear top rail. Fix the unit in position using suitable fixings.

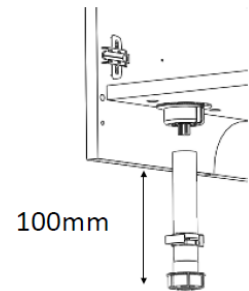

Drawer Box Removal and Replacement

To remove the drawer box, pull the drawer fully out and lift it upwards. To re-fit the drawer box, pull the runners fully out, place the drawer box on the runners and push it rearwards until it clicks into place.



Drawer Front Removal

Slide the drawer side covers rearwards to expose the screws. Using a crosshead screwdriver, turn the screws shown to release the drawer front. Where there are two screws on each drawer side, turn the top screw first followed by the bottom one.



Drawer Front Adjustment

Slide the drawer side covers rearwards to expose the adjustment screws. To raise or lower the drawer front, turn the larger screws with a crosshead screwdriver until adjusted as required. To move the drawer front from side to side, turn the smaller screws. To adjust the tilt of the drawer front, remove the caps from the tops of the drawer sides. Use a cross-head screwdriver to adjust as required.



Installing Metal Trim

- Cut the metal trim to the required length to suit the run of units.
- Place the trim over the fixing clips on the gable panels.
- Insert the T bolt and turn it 90°.
- Slide the T bolt to the end of the trim to lock it in position.

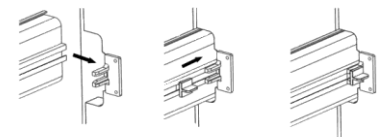

Care & Maintenance

Furniture should be regularly dusted with a soft cotton or micro-fibre cloth. For more thorough cleaning, occasionally wipe your furniture with a soft cloth dampened with a mild detergent solution. Surfaces should be thoroughly dried with a lint free cloth to prevent watermarks. Under no circumstances should solvent cleaning agents, bleach or abrasive cleaning agents or cloths be used. Spills should be removed immediately using a clean cloth. Glass or mirrored panels should be cleaned using a non-solvent based glass cleaner and a soft cloth. All bathroom furniture will deteriorate through prolonged periods of exposure to high levels of condensation so bathrooms must be adequately ventilated using suitable extraction. Failure to ensure adequate ventilation may invalidate your guarantee.

Installation Guide

Contemporary Fitted Double Base Door Unit

Utopia

Bathroom Perfection

Important Information

- Read the instructions carefully.
- Check the product for any signs of damage and remove any protective film.
- It is recommended that a technically competent installer undertakes installation.
- It is the installer's responsibility to carry out a thorough assessment of the wall type and the weight of the cabinet and use appropriate fixings.
- Care should be taken when drilling walls to avoid any hidden wires or pipes.

Installation

Remove the shelf, turn the unit upside down and push the legs firmly into the leg sockets.

Stand the unit back on its legs against the wall. Adjust the legs so that it is level and there is 100mm from bottom of the gable to the floor.

If fitting a run of units, fix them together through the gable panels. Where possible, try to hide the fixings behind shelves or hinge plates.

To secure the unit against the wall, drill through the rear top rail. Fix the unit in position using suitable fixings.

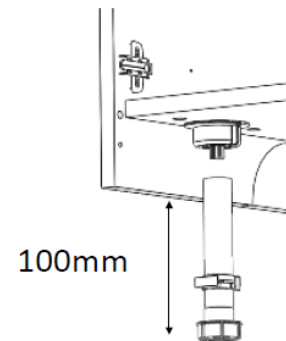

Door hinge adjustment

- To square the door against the cabinet, turn screws A until adjusted as required.
- To adjust the door closer to or further away from the cabinet, turn screws B.
- To adjust the door vertically, slacken screws C. Re-tighten once the door is adjusted as required.
- To remove the door hinges from the cabinet, press button D.
- To remove the door hinges from the door, remove screws E.

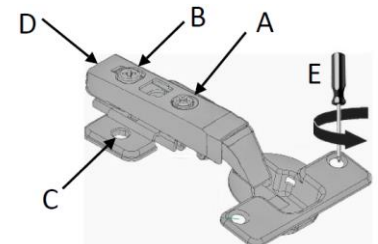

Installing metal trim.

- Cut the metal trim to the required length.
- Place the trim over the fixing clips on the gable panels.
- Insert the T bolt and turn it 90°.
- Slide the T bolt to the end of the trim to lock it in position.

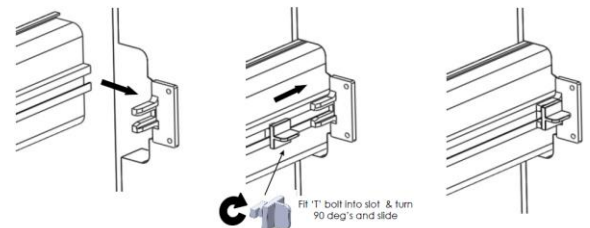

Care & Maintenance

Furniture should be regularly dusted with a soft cotton or micro-fibre cloth. For more thorough cleaning, occasionally wipe your furniture with a soft cloth dampened with a mild detergent solution. Surfaces should be thoroughly dried with a lint free cloth to prevent watermarks. Under no circumstances should solvent cleaning agents, bleach or abrasive cleaning agents or cloths be used. Spills should be removed immediately using a clean cloth. Glass or mirrored panels should be cleaned using a non-solvent based glass cleaner and a soft cloth. All bathroom furniture will deteriorate through prolonged periods of exposure to high levels of condensation so bathrooms must be adequately ventilated using suitable extraction. Failure to ensure adequate ventilation may invalidate your guarantee.

Installation Guide

Contemporary Fitted Double Base Drawer Unit

Utopia

Bathroom Perfection

Important Information

- Read the instructions carefully.
- Check the product for any signs of damage and remove any protective film.
- It is recommended that a technically competent installer undertakes installation.
- It is the installer's responsibility to carry out a thorough assessment of the wall type and the weight of the cabinet and use appropriate fixings.
- Care should be taken when drilling walls to avoid any hidden wires or pipes.

Installation

Remove the shelf, turn the unit upside down and push the legs firmly into the leg sockets.

Stand the unit back on its legs against the wall. Adjust the legs so that it is level and there is 100mm from bottom of the gable to the floor.

If fitting a run of units, fix them together through the gable panels. Where possible, try to hide the fixings behind shelves or hinge plates.

To secure the unit against the wall, drill through the rear top rail. Fix the unit in position using suitable fixings.

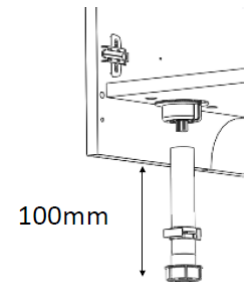

Drawer Box Removal and Replacement

To remove the drawer box, pull the drawer fully out and lift it upwards. To re-fit the drawer box, pull the runners fully out, place the drawer box on the runners and push it rearwards until it clicks into place.



Drawer Front Removal

Slide the drawer side covers rearwards to expose the screws. Using a crosshead screwdriver, turn the screws shown to release the drawer front. Where there are two screws on each drawer side, turn the top screw first followed by the bottom one.



Drawer Front Adjustment

Slide the drawer side covers rearwards to expose the adjustment screws. To raise or lower the drawer front, turn the larger screws with a crosshead screwdriver until adjusted as required. To move the drawer front from side to side, turn the smaller screws. To adjust the tilt of the drawer front, remove the caps from the tops of the drawer sides. Use a cross-head screwdriver to adjust as required.



Installing metal trim.

- Cut the metal trim to the required length.
- Place the trim over the fixing clips on the gable panels.
- Insert the T bolt and turn it 90°.
- Slide the T bolt to the end of the trim to lock it in position.

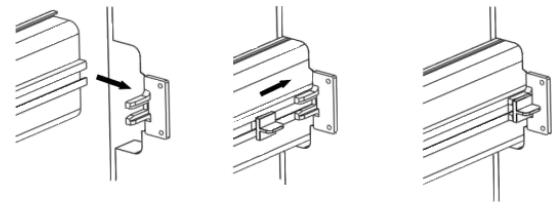

Care & Maintenance

Furniture should be regularly dusted with a soft cotton or micro-fibre cloth. For more thorough cleaning, occasionally wipe your furniture with a soft cloth dampened with a mild detergent solution. Surfaces should be thoroughly dried with a lint free cloth to prevent watermarks. Under no circumstances should solvent cleaning agents, bleach or abrasive cleaning agents or cloths be used. Spills should be removed immediately using a clean cloth. Glass or mirrored panels should be cleaned using a non-solvent based glass cleaner and a soft cloth. All bathroom furniture will deteriorate through prolonged periods of exposure to high levels of condensation so bathrooms must be adequately ventilated using suitable extraction. Failure to ensure adequate ventilation may invalidate your guarantee.

Installation Guide

Contemporary Fitted Tall Sit-On Unit

Utopia

Bathroom Perfection

Important Information

- Read the instructions carefully.
- Check the product for any signs of damage and remove any protective film.
- It is the installer's responsibility to carry out a thorough assessment of wall type and the weight of the cabinet and use appropriate fixings.
- Care should be taken when drilling walls to avoid any hidden wires or pipes.
- To prevent the cabinet falling down this product must be fixed using the wall attachment device provided.

Installation

It may be necessary to snap the wall plate in half at the marked line to create two wall brackets. Mark a horizontal line on the wall at the required height X---X. Ensure that the wall brackets will fit inside the width of the cabinet and are equally spaced to ensure even distribution of weight. Secure the wall brackets to the wall using suitable fixings.

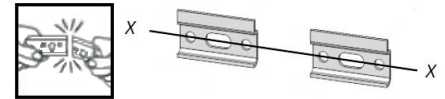

Hook the unit onto the wall brackets ensuring that the brackets are securely located.

To alter the position of the cabinet on the wall, adjust the two screws in each hanging bracket. The top screws will move the cabinet closer to or further away from the wall. The lower screws will move the cabinet up and down.

A securing screw should be fitted through the fixed back of the cabinet and into the wall, to stabilise the unit.

If this cabinet is being fitted in a run, secure the units together with suitable fixings through the gables. Try to hide the fixings where possible behind shelves or hinge plates.

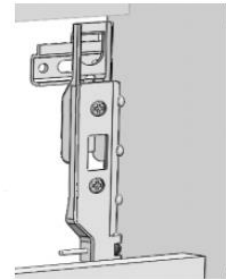

Door adjustment

- To square the door against the cabinet, turn screws A until adjusted as required.
- To move the door closer to or further away from the cabinet, adjust screws B.
- To adjust the door vertically, slacken screws C. Re-tighten once the door is adjusted as required.
- To remove the door hinges from the cabinet, press button D. To remove the door from the door hinges, remove screws E.

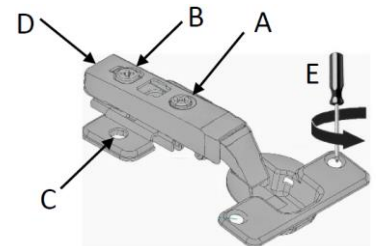

Installing Metal Trim

- Cut the metal trim to the required length to suit the run of units.
- Place the trim over the fixing clips on the gable panels.
- Insert the T bolt and turn it 90°.
- Slide the T bolt to the end of the trim to lock it in position.

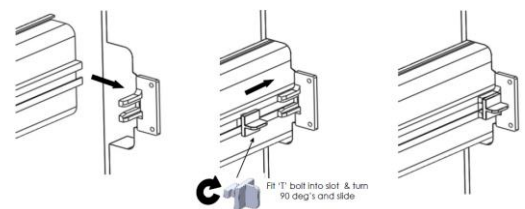

Care & Maintenance

Furniture should be regularly dusted with a soft cotton or micro-fibre cloth. For more thorough cleaning, occasionally wipe your furniture with a soft cloth dampened with a mild detergent solution. Surfaces should be thoroughly dried with a lint free cloth to prevent watermarks. Under no circumstances should solvent cleaning agents, bleach or abrasive cleaning agents or cloths be used. Spills should be removed immediately using a clean cloth. Glass or mirrored panels should be cleaned using a non-solvent based glass cleaner and a soft cloth. All bathroom furniture will deteriorate through prolonged periods of exposure to high levels of condensation so bathrooms must be adequately ventilated using suitable extraction. Failure to ensure adequate ventilation may invalidate your guarantee.

Installation Guide

Contemporary Fitted Single Wall Unit

Utopia

Bathroom Perfection

Important Information

- Read the instructions carefully.
- Check the product for any signs of damage and remove any protective film.
- It is the installer's responsibility to carry out a thorough assessment of wall type and the weight of the cabinet and use appropriate fixings.
- Care should be taken when drilling walls to avoid any hidden wires or pipes.
- To prevent the cabinet falling down this product must be fixed using the wall attachment device provided.

Installation

It may be necessary to snap the wall plate in half at the marked line to create two wall brackets. Mark a horizontal line on the wall at the required height X---X. Ensure that the wall brackets will fit inside the width of the cabinet and are equally spaced to ensure even distribution of weight. Secure the wall brackets to the wall using suitable fixings.

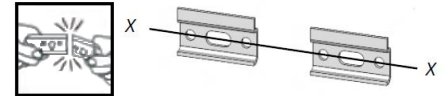

Hook the unit onto the wall brackets ensuring that the brackets are securely located.

To alter the position of the cabinet on the wall, adjust the two screws in each hanging bracket. The top screws will move the cabinet closer to or further away from the wall. The lower screws will move the cabinet up and down.

If this cabinet is being fitted in a run, secure the units together with suitable fixings through the gables. Try to hide the fixings where possible behind shelves or hinge plates.

A securing screw should be fitted through the back of the unit through the fixed back of the cabinet and into the wall, this will help to stabilise the unit.

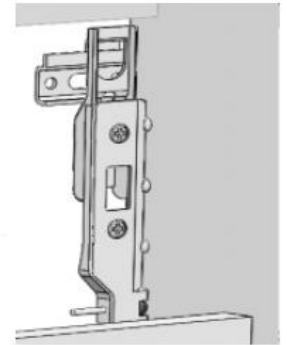

Door adjustment

- To square the door against the cabinet, turn screws A until adjusted as required.
- To move the door closer to or further away from the cabinet, adjust screws B.
- To adjust the door vertically, slacken screws C. Re-tighten once the door is adjusted as required.
- To remove the door hinges from the cabinet, press button D.
- To remove the door from the door hinges, remove screws E.

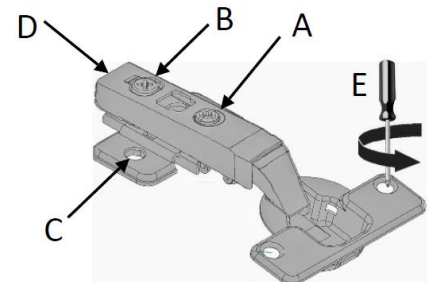

Care & Maintenance

Furniture should be regularly dusted with a soft cotton or micro-fibre cloth. For more thorough cleaning, occasionally wipe your furniture with a soft cloth dampened with a mild detergent solution. Surfaces should be thoroughly dried with a lint free cloth to prevent watermarks. Under no circumstances should solvent cleaning agents, bleach or abrasive cleaning agents or cloths be used. Spills should be removed immediately using a clean cloth. Glass or mirrored panels should be cleaned using a non-solvent based glass cleaner and a soft cloth. All bathroom furniture will deteriorate through prolonged periods of exposure to high levels of condensation so bathrooms must be adequately ventilated using suitable extraction. Failure to ensure adequate ventilation may invalidate your guarantee.

Installation Guide

Contemporary Fitted Double Wall Unit

Utopia

Bathroom Perfection

Important Information

- Read the instructions carefully.
- Check the product for any signs of damage and remove any protective film.
- It is the installer's responsibility to carry out a thorough assessment of wall type and the weight of the cabinet and use appropriate fixings.
- Care should be taken when drilling walls to avoid any hidden wires or pipes.
- To prevent the cabinet falling down this product must be fixed using the wall attachment device provided.

Installation

It may be necessary to snap the wall plate in half at the marked line to create two wall brackets. Mark a horizontal line on the wall at the required height X---X. Ensure that the wall brackets will fit inside the width of the cabinet and are equally spaced to ensure even distribution of weight. Secure the wall brackets to the wall using suitable fixings.

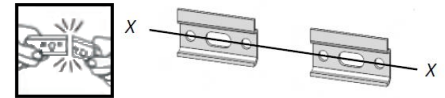

Hook the unit onto the wall brackets ensuring that the brackets are securely located.

To alter the position of the cabinet on the wall, adjust the two screws in each hanging bracket. The top screws will move the cabinet closer to or further away from the wall. The lower screws will move the cabinet up and down.

A securing screw should be fitted through the back of the unit through the fixed back of the cabinet and into the wall, this will help to stabilise the unit.

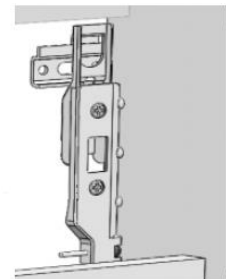

If this cabinet is being fitted in a run, secure the units together with suitable fixings through the gables. Try to hide the fixings where possible behind shelves or hinge plates.

Door adjustment

- To square the door against the cabinet, turn screws A until adjusted as required.
- To move the door closer to or further away from the cabinet, adjust screws B.
- To adjust the door vertically, slacken screws C. Re-tighten once the door is adjusted as required.
- To remove the door hinges from the cabinet, press button D.
- To remove the door from the door hinges, remove screws E.

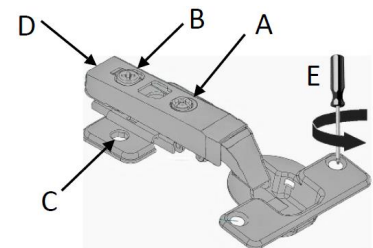

Care & Maintenance

Furniture should be regularly dusted with a soft cotton or micro-fibre cloth. For more thorough cleaning, occasionally wipe your furniture with a soft cloth dampened with a mild detergent solution. Surfaces should be thoroughly dried with a lint free cloth to prevent watermarks. Under no circumstances should solvent cleaning agents, bleach or abrasive cleaning agents or cloths be used. Spills should be removed immediately using a clean cloth. Glass or mirrored panels should be cleaned using a non-solvent based glass cleaner and a soft cloth. All bathroom furniture will deteriorate through prolonged periods of exposure to high levels of condensation so bathrooms must be adequately ventilated using suitable extraction. Failure to ensure adequate ventilation may invalidate your guarantee.

Installation Guide

Contemporary Fitted Mirror Cabinet

Utopia

Bathroom Perfection

Important Information

- Read the instructions carefully.
- Check the product for any signs of damage and remove any protective film.
- It is the installer's responsibility to carry out a thorough assessment of wall type and the weight of the cabinet and use appropriate fixings.
- Care should be taken when drilling walls to avoid any hidden wires or pipes.
- To prevent the cabinet falling down this product must be fixed using the wall attachment device provided.

Installation

It may be necessary to snap the wall plate in half at the marked line to create two wall brackets. Mark a horizontal line on the wall at the required height X---X. Ensure that the wall brackets will fit inside the width of the cabinet and are equally spaced to ensure even distribution of weight. Secure the wall brackets to the wall using suitable fixings.

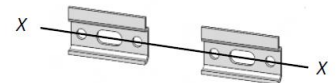

Hook the unit onto the wall brackets ensuring that the brackets are securely located.

To alter the position of the cabinet on the wall, adjust the two screws in each hanging bracket. The top screws will move the cabinet closer to or further away from the wall. The lower screws will move the cabinet up and down.

A securing screw should be fitted through the back of the unit through the fixed back of the cabinet and into the wall, this will help to stabilise the unit.

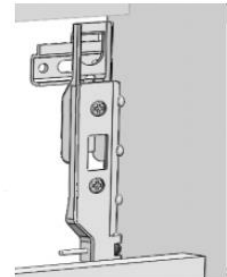

If this cabinet is being fitted in a run, secure the units together with suitable fixings through the gables. Try to hide the fixings where possible behind shelves or hinge plates.

Door adjustment

- To square the door against the cabinet, turn screws A until adjusted as required.
- To move the door closer to or further away from the cabinet, adjust screws B.
- To adjust the door vertically, slacken screws C. Re-tighten once the door is adjusted as required.
- To remove the door hinges from the cabinet, press button D.
- To remove the door from the door hinges, remove screws E.

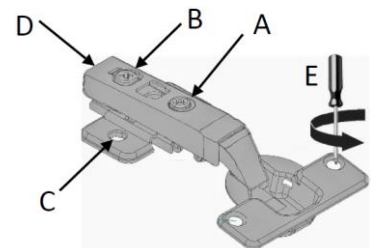

Care & Maintenance

Furniture should be regularly dusted with a soft cotton or micro-fibre cloth. For more thorough cleaning, occasionally wipe your furniture with a soft cloth dampened with a mild detergent solution. Surfaces should be thoroughly dried with a lint free cloth to prevent watermarks. Under no circumstances should solvent cleaning agents, bleach or abrasive cleaning agents or cloths be used. Spills should be removed immediately using a clean cloth. Glass or mirrored panels should be cleaned using a non-solvent based glass cleaner and a soft cloth. All bathroom furniture will deteriorate through prolonged periods of exposure to high levels of condensation so bathrooms must be adequately ventilated using suitable extraction. Failure to ensure adequate ventilation may invalidate your guarantee.

Installation Guide

Contemporary Fitted Mirror Cabinet

Important Information

- Read the instructions carefully.
- Check the product for any signs of damage and remove any protective film.
- It is recommended that this product is fitted by a suitably qualified Part P registered electrician in accordance with current IEE & Building Regulations.
- It is the installer's responsibility to carry out a thorough assessment of wall type and the weight of the cabinet and use appropriate fixings.
- Care should be taken when drilling walls to avoid any hidden wires or pipes.
- To prevent the cabinet falling down this product must be fixed using the wall attachment device provided.
- The terminal block used to connect the leads to the electrical supply can be of either the screw- or screw-less type and should be rated at 240V 6A with 4 terminals. The cable tails do not need to be crimped when connected to the terminal block.
- This product should be used only with a mains supply that is protected by a 30mA Residual Current Device.
- This product is IP20 rated and is only suitable for installation in Outside Zones in a bathroom. It is not suitable to be fitted in zones 0, 1 or 2.

Connection to Mains Electrics

1. Turn off the electrical supply.
2. The top front panel of the cabinet can be removed to access the electrical connections.
3. Connect the electrical supply in the bathroom to the shaver socket transformer cable (A).
4. Turn the electrical supply back on and check that the shaver socket functions as required.

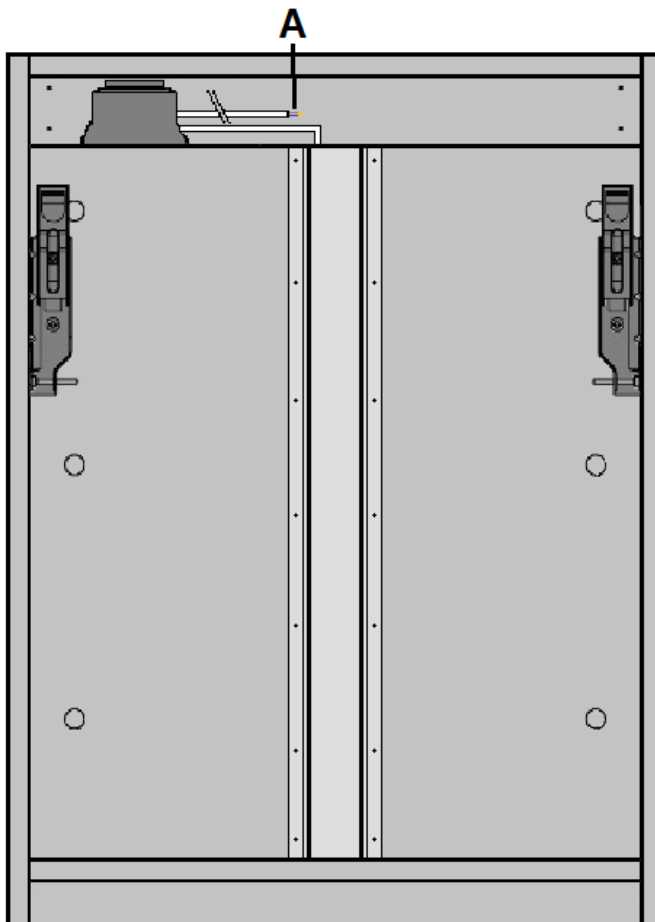

WARNING
RISK OF ELECTRIC SHOCK
Turn off mains electric prior to commencing work.

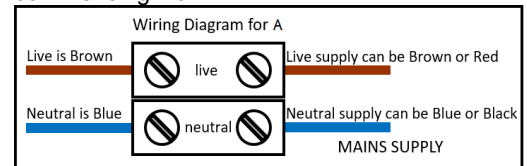

Bathroom Lighting Zone

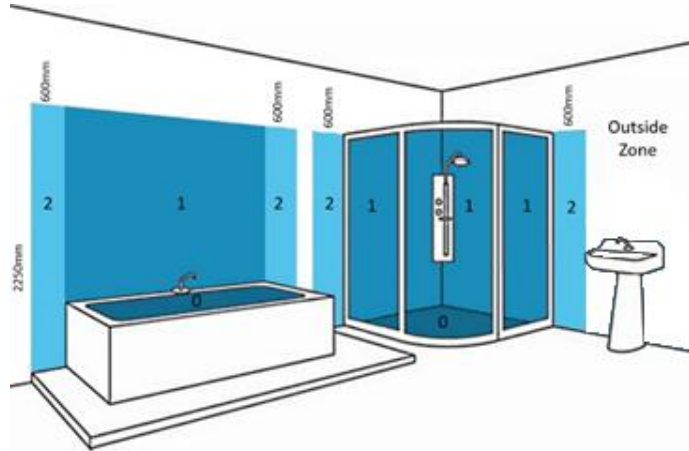

Fitting Cabinet to Wall

It may be necessary to snap the wall plate in half at the marked line to create two wall brackets. Mark a horizontal line on the wall at the required height X---X. Ensure that the wall brackets will fit inside the width of the cabinet and are equally spaced to ensure even distribution of weight. Secure the wall brackets to the wall using suitable fixings.

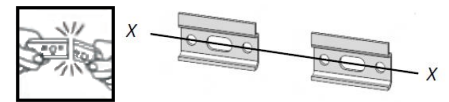

Hook the unit onto the wall brackets ensuring that the brackets are securely located.

To alter the position of the cabinet on the wall, adjust the two screws in each hanging bracket. The top screws will move the cabinet closer to or further away from the wall. The lower screws will move the cabinet up and down.

A securing screw should be fitted through the back of the unit through the fixed back of the cabinet and into the wall, this will help to stabilise the unit.

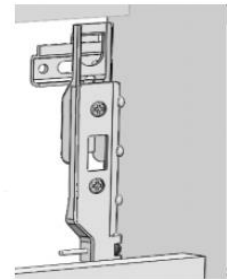

Door adjustment

- To square the door against the cabinet, turn screws A until adjusted as required.
- To move the door closer to or further away from the cabinet, adjust screws B.
- To adjust the door vertically, slacken screws C. Re-tighten once the door is adjusted as required.
- To remove the door hinges from the cabinet, press button D.
- To remove the door from the door hinges, remove screws E.

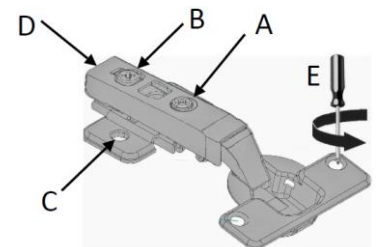

Care & Maintenance

Furniture should be regularly dusted with a soft cotton or micro-fibre cloth. For more thorough cleaning, occasionally wipe your furniture with a soft cloth dampened with a mild detergent solution. Surfaces should be thoroughly dried with a lint free cloth to prevent watermarks. Under no circumstances should solvent cleaning agents, bleach or abrasive cleaning agents or cloths be used. Glass or mirrored panels should be cleaned using a non-solvent based glass cleaner and a soft cloth. Spills should be removed immediately using a clean cloth. All bathroom furniture will deteriorate through prolonged periods of exposure to high levels of condensation so bathrooms must be adequately ventilated using suitable extraction. Failure to ensure adequate ventilation may invalidate your guarantee.

Installation Guide

Contemporary Fitted Bath Side Panel

Important Information

- Read the instructions carefully.
- Check the product for any signs of damage and remove any protective film.
- It is recommended that a technically competent installer undertakes installation.
- It is the installer's responsibility to carry out a thorough assessment of the wall type and use appropriate fixings.
- Care should be taken when drilling walls to avoid any hidden wires or pipes.

Installation

Set the height of the bath to suit the height of the bath panel according to the instructions supplied with the bath.



Ensure that when the brackets and bath panel are fitted, the panel sits 4mm proud of the bath rim.

If you are installing this side panel in conjunction with an end panel, fit the end panel first according to the instructions supplied with it.

Screw three black Keku clips to the underside of the wooden batten underneath the bath rim using the screws provided. The three clips should be equally spaced along the length of the bath. Use the diagram as a guide to how the Keku clips are fitted.

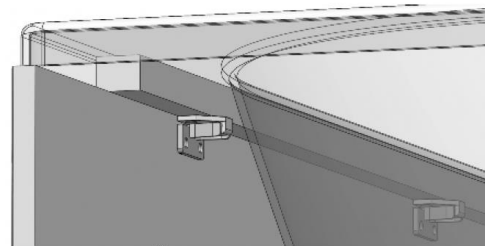

The matching Keku clips should be screwed to the rear of the bath panel using the screws supplied. Measure carefully to ensure that the clips on the rear of the bath panel will engage with the clips screwed to the bath.

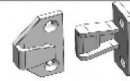

If the bath panel is being fitted between two walls, the two "L" brackets should be secured to the walls to prevent the panel from being pushed inwards. Ensure suitable fixings are used.

If the bath panel is being used in conjunction with an end panel, secure one "L" bracket to the wall to prevent the panel from being pushed inwards. On the opposite side to the wall, secure the bath panel in place using a Keku clip. This Keku clip is supplied with the end panel, along with instruction on how it is fitted.

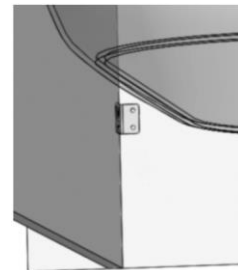

Once fully installed, seal around the bath panel on all joints using a good quality, sanitary-grade silicone sealant.

Care & Maintenance

Furniture should be regularly dusted with a soft cotton or micro-fibre cloth. For more thorough cleaning, occasionally wipe your furniture with a soft cloth dampened with a mild detergent solution. Surfaces should be thoroughly dried with a lint free cloth to prevent watermarks. Under no circumstances should solvent cleaning agents, bleach or abrasive cleaning agents or cloths be used. Glass or mirrored panels should be cleaned using a non-solvent based glass cleaner and a soft cloth. Spills should be removed immediately using a clean cloth. All bathroom furniture will deteriorate through prolonged periods of exposure to high levels of condensation so bathrooms must be adequately ventilated using suitable extraction. Failure to ensure adequate ventilation may invalidate your guarantee.

Installation Guide

Contemporary Fitted Bath End Panel

Important Information

- Read the instructions carefully.
- Ensure product contents are complete.
- Check the product for any signs of damage and remove any protective film.
- It is recommended that a technically competent installer undertakes installation.
- It is the installer's responsibility to carry out a thorough assessment of the wall type and use appropriate fixings.
- Care should be taken when drilling to avoid any hidden wires or pipes.

Installation

Set the height of the bath to suit the height of the bath panel according to the instructions supplied with the bath

Fit the end panel before installing the side panel

Ensure that when the brackets and bath panel are fitted, the panel sits 4mm proud of the bath rim.



Secure one "L" bracket to the wall using suitable fixings. It is recommended that the bracket is fitted 300mm vertically from the underside of the bath.

Secure the second "L" bracket to the underside of the wooden batten under the bath rim using the screws provided.

Screw one of the black Keku clips to the opposite side of the end panel to the wall. The matching Keku clip should be screwed to the back of the front panel. Use the diagram as a guide to how these are fitted.

Once fully installed, seal around the bath panel on all joints using a good quality, sanitary-grade silicone sealant.

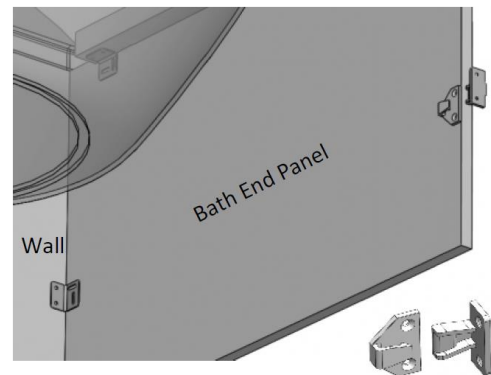

Care & Maintenance

Furniture should be regularly dusted with a soft cotton or micro-fibre cloth. For more thorough cleaning, occasionally wipe your furniture with a soft cloth dampened with a mild detergent solution. Surfaces should be thoroughly dried with a lint free cloth to prevent watermarks. Under no circumstances should solvent cleaning agents, bleach or abrasive cleaning agents or cloths be used. Glass or mirrored panels should be cleaned using a non-solvent based glass cleaner and a soft cloth. Spills should be removed immediately using a clean cloth. All bathroom furniture will deteriorate through prolonged periods of exposure to high levels of condensation so bathrooms must be adequately ventilated using suitable extraction. Failure to ensure adequate ventilation may invalidate your guarantee.