

Installation Guide

Qube Glide Freestanding Double Drawer Unit

Important Information

- Read the instructions carefully.
- Check the product for any signs of damage and remove any protective film.
- It is recommended that a technically competent installer undertakes the installation.
- It is the installer's responsibility to carry out a thorough assessment of the wall type and the weight of the cabinet and use appropriate fixings.
- Care should be taken when drilling walls to avoid any hidden wires or pipes.

Installation

Remove the drawers from the cabinet. To secure the unit against the wall, screw the stretcher plates to the gable panels of the cabinet as shown in the diagram. Ensure that the screws used are suitable for the thickness of the cabinet.

Mark the position of the holes in the stretcher plates on the wall with a pencil. Drill the positions marked with a suitable drill bit.

Fasten the unit in position through the stretcher plates using fixings suitable for the wall type.

If fitting a run of units, fix them together through the gable panels. Where possible, try to hide the fixings behind shelves or hinge plates.

Secure the basin to the cabinet using a good quality, sanitary-grade silicone sealant.

It is good practise to run a bead of silicone where the furniture meets the floor and walls.

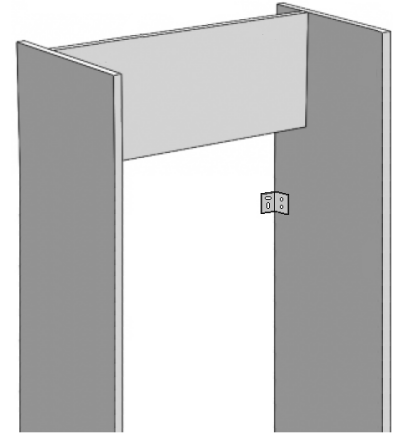

Drawer Adjustment

- To remove the drawer box from the runners, pull the drawer out and remove the cover caps from the drawer sides. Lift the catches (A) on either side and release the drawer box from the runners. When re-fitting the drawer box, ensure that the runners have fully engaged at the rear. An audible click should be heard as the drawer box is closed, engaging the drawer box onto the runners.
- To raise or lower the drawer front, use a screwdriver to rotate screw B.
- To remove the drawer front, use a screwdriver to rotate screw C.
- To adjust the drawer front left to right, use a screwdriver to rotate screw D.
- Adjust the screws until the drawer front is equally spaced on the cabinet.



Care & Maintenance

Furniture should be regularly dusted with a soft cotton or micro-fibre cloth. For more thorough cleaning, occasionally wipe your furniture with a soft cloth dampened with a mild detergent solution. Surfaces should be thoroughly dried with a lint free cloth to prevent watermarks. Under no circumstances should solvent cleaning agents, bleach or abrasive cleaning agents or cloths be used. Spills should be removed immediately using a clean cloth. All bathroom furniture will deteriorate through prolonged periods of exposure to high levels of condensation so bathrooms must be adequately ventilated using suitable extraction. Failure to ensure adequate ventilation may invalidate your guarantee.

Installation Guide

Qube Glide Freestanding Double Door Unit

Important Information

- Read the instructions carefully.
- Check the product for any signs of damage and remove any protective film.
- It is recommended that a technically competent installer undertakes the installation.
- It is the installer's responsibility to carry out a thorough assessment of the wall type and the weight of the cabinet and use appropriate fixings.
- Care should be taken when drilling walls to avoid any hidden wires or pipes.

Installation

Remove the doors from the cabinet. To secure the unit against the wall, screw the stretcher plates to the gable panels of the cabinet as shown in the diagram. Ensure that the screws used are suitable for the thickness of the cabinet.

Mark the position of the holes in the stretcher plates on the wall with a pencil. Drill the positions marked with a suitable drill bit.

Fasten the unit in position through the stretcher plates using fixings suitable for the wall type.

Secure the basin to the cabinet using a good quality, sanitary-grade silicone sealant.

It is good practise to run a bead of silicone where the furniture meets the floor and walls.

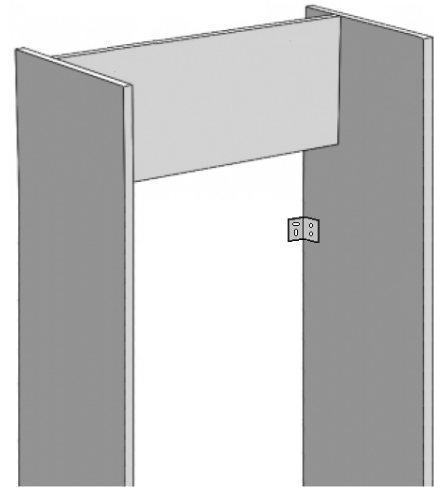

Door hinge adjustment

- To square the door against the cabinet, turn screws A until adjusted as required.
- To adjust the door closer to or further away from the cabinet, turn screws B.
- To adjust the door vertically, slacken screws C. Re-tighten once the door is adjusted as required.
- To remove the door hinges from the cabinet, press button D.
- To remove the door hinges from the door, remove screws E.

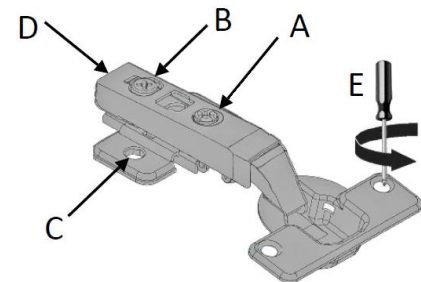

Care & Maintenance

Furniture should be regularly dusted with a soft cotton or micro-fibre cloth. For more thorough cleaning, occasionally wipe your furniture with a soft cloth dampened with a mild detergent solution. Surfaces should be thoroughly dried with a lint free cloth to prevent watermarks. Under no circumstances should solvent cleaning agents, bleach or abrasive cleaning agents or cloths be used. Spills should be removed immediately using a clean cloth. All bathroom furniture will deteriorate through prolonged periods of exposure to high levels of condensation so bathrooms must be adequately ventilated using suitable extraction. Failure to ensure adequate ventilation may invalidate your guarantee.

Installation Guide

Qube Glide Wall Mounted Double Drawer Washbasin Unit

Important Information

- Read the instructions carefully.
- Ensure product contents are complete.
- Check the product for any signs of damage and remove any protective film.
- It is recommended that a technically competent installer undertakes the installation.
- It is the installer's responsibility to carry out a thorough assessment of the installation environment (i.e. wall type/structure and the combined weight of the cabinet and basin) and use appropriate fixings.
- Care should be taken when drilling to avoid any hidden wires or pipes.
- To prevent the cabinet falling from the wall this product must be fixed using the wall attachment device and brackets provided.

Installation

Mark a horizontal line on the wall at the required height **X---X**. Ensure that the wall brackets will fit inside the width of the cabinet and are equally spaced to ensure even distribution of weight. Secure the wall brackets to the wall using suitable fixings.

Hook the unit onto the wall brackets so that the spring locks the arm into place.

To alter the position of the cabinet on the wall, adjust the two screws in each hanging bracket. Adjusting screws A will move the cabinet up and down. When the cabinet is level on the wall, screws B will tighten the cabinet to the wall.

A securing screw should be fitted through the back of the unit through the fixed back rail of the cabinet and into the wall. This will help to stabilise the unit.

Secure the basin to the cabinet using a good quality, sanitary-grade silicone sealant.

It is good practise to run a bead of silicone where the furniture and basin meets the walls.

Drawer Adjustment

- To remove the drawer box from the runners, pull the drawer out and remove the cover caps from the drawer sides. Lift the catches (A) on either side and release the drawer box from the runners. When re-fitting the drawer box, ensure that the runners have fully engaged at the rear. An audible click should be heard as the drawer box is closed, engaging the drawer box onto the runners.
- To raise or lower the drawer front, use a screwdriver to rotate screw B.
- To remove the drawer front, use a screwdriver to rotate screw C.
- To adjust the drawer front left to right, use a screwdriver to rotate screw D.
- Adjust the screws until the drawer front is equally spaced on the cabinet.

Care & Maintenance

Furniture should be regularly dusted with a soft cotton or micro-fibre cloth. For more thorough cleaning, occasionally wipe your furniture with a soft cloth dampened with a mild detergent solution. Surfaces should be thoroughly dried with a lint free cloth to prevent watermarks. Under no circumstances should solvent cleaning agents, bleach or abrasive cleaning agents or cloths be used. Spills should be removed immediately using a clean cloth. All bathroom furniture will deteriorate through prolonged periods of exposure to high levels of condensation so bathrooms must be adequately ventilated using suitable extraction. Failure to ensure adequate ventilation may invalidate your guarantee.

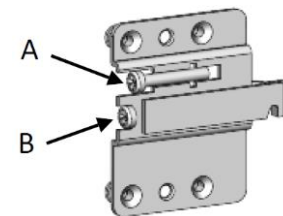
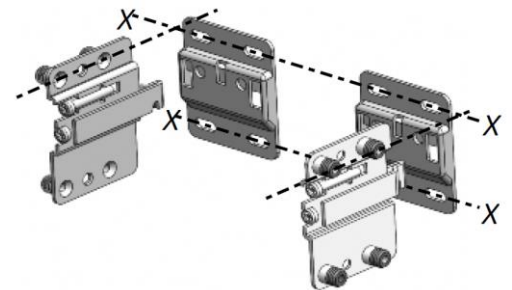

Installation Guide

Qube Glide Cloakroom Washbasin Unit



Bathroom Perfection

Important Information

- Read the instructions carefully.
- Ensure product contents are complete.
- Check the product for any signs of damage and remove all protective film.
- It is recommended that a technically competent installer undertakes the installation.
- It is the installer's responsibility to carry out a thorough assessment of wall type and the weight of the cabinet and use appropriate fixings.
- Care should be taken when drilling to avoid any hidden wires or pipes.
- To prevent the cabinet falling from the wall this product must be fixed using the wall attachment device provided.

Installation

Remove the doors from the cabinet. It may be necessary to snap the wall plate in half at the marked line to create two wall brackets. Mark a horizontal line on the wall at the required height X---X. Ensure that the wall brackets will fit inside the width of the cabinet and are equally spaced to ensure even distribution of weight. Secure the wall brackets to the wall using suitable fixings.

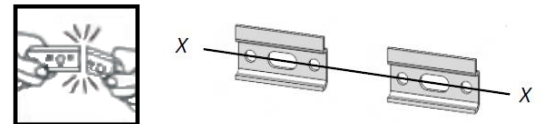

Hook the unit onto the wall brackets ensuring that the brackets are securely located.

To adjust the position of the cabinet on the wall, use the two screws in each hanging bracket. The top screws will move the cabinet closer to or further away from the wall. The lower screws will move the cabinet up and down.

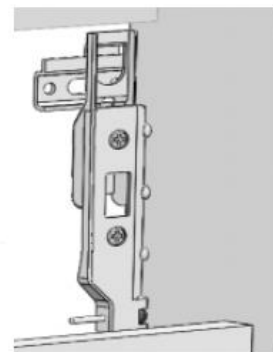

Secure the basin to the cabinet using a good quality, sanitary-grade silicone sealant.

It is good practise to run a bead of silicone where the furniture and basin meets the walls.

Door hinge adjustment

- To square the door against the cabinet, turn screws A until adjusted as required.
- To adjust the door closer to or further away from the cabinet, turn screws B.
- To adjust the door vertically, slacken screws C. Re-tighten once the door is adjusted as required.
- To remove the door hinges from the cabinet, press button D.
- To remove the door hinges from the door, remove screws E.

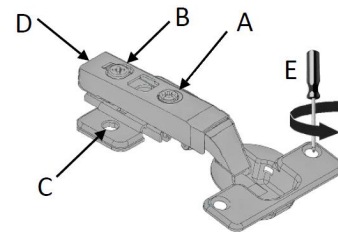

Care & Maintenance

Furniture should be regularly dusted with a soft cotton or micro-fibre cloth. For more thorough cleaning, occasionally wipe your furniture with a soft cloth dampened with a mild detergent solution. Surfaces should be thoroughly dried with a lint free cloth to prevent watermarks. Under no circumstances should solvent cleaning agents, bleach or abrasive cleaning agents or cloths be used. Spills should be removed immediately using a clean cloth. All bathroom furniture will deteriorate through prolonged periods of exposure to high levels of condensation so bathrooms must be adequately ventilated using suitable extraction. Failure to ensure adequate ventilation may invalidate your guarantee.

Installation Guide

Qube Back-To-Wall Toilet Unit

Important Information

- Read the instructions carefully.
- Check the product for any signs of damage and remove any protective film.
- It is recommended that a technically competent installer undertakes the installation.
- It is the installer's responsibility to carry out a thorough assessment of the wall type and the weight of the cabinet and use appropriate fixings.
- Care should be taken when drilling walls to avoid any hidden wires or pipes.

Installation

Remove the top fascia panel first by pulling it away from the cabinet with equal force on each side. Remove the lower fascia by lifting it upwards.

To secure the WC unit against the wall, screw the stretcher plates to the gable panels of the cabinet as shown in the diagram. Ensure that the screws used are suitable for the thickness of the cabinet.

Mark the position of the holes in the stretcher plates on the wall with a pencil. Drill the positions marked with a suitable drill bit.

Fasten the unit in position through the stretcher plates using fixings suitable for the wall type.

If you are fitting a wall-hung pan frame in this cabinet it may be necessary to remove the bottom rail from the cabinet.

To cut the lower fascia panel to accommodate the soil pipe and cistern flush pipe, use a jigsaw with a fine-toothed blade suitable for timber. Ensure that the room is well ventilated when cutting the material.

All cut edges must be sealed with PVA glue or good-quality, sanitary grade silicone sealant to prevent the ingress of moisture.

Re-fit the lower fascia, followed by the top fascia panel.

It is good practise to run a bead of silicone where the furniture meets the floor and walls.

Care & Maintenance

Furniture should be regularly dusted with a soft cotton or micro-fibre cloth. For more thorough cleaning, occasionally wipe your furniture with a soft cloth dampened with a mild detergent solution. Surfaces should be thoroughly dried with a lint free cloth to prevent watermarks. Under no circumstances should solvent cleaning agents, bleach or abrasive cleaning agents or cloths be used. Spills should be removed immediately using a clean cloth. All bathroom furniture will deteriorate through prolonged periods of exposure to high levels of condensation so bathrooms must be adequately ventilated using suitable extraction. Failure to ensure adequate ventilation may invalidate your guarantee.

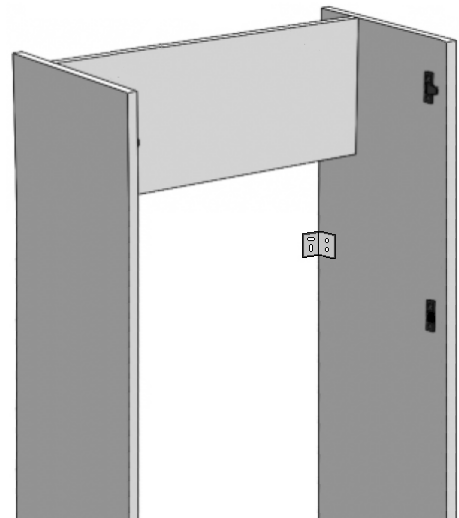

Installation Guide

Qube Tall Back-To-Wall Toilet Unit

Important Information

- Read the instructions carefully.
- Check the product for any signs of damage and remove any protective film.
- It is recommended that a technically competent installer undertakes the installation.
- It is the installer's responsibility to carry out a thorough assessment of the wall type and the weight of the cabinet and use appropriate fixings.
- Care should be taken when drilling walls to avoid any hidden wires or pipes.

Installation

Remove the top fascia panel first by pulling it away from the cabinet with equal force on each side. Remove the lower fascia by lifting it upwards.

Secure the unit to the wall by drilling through the back rail and using suitable fixings for the wall type.

If you are fitting a wall-hung pan frame in this cabinet it may be necessary to remove the bottom rail from the cabinet.

To cut the lower fascia panel to accommodate the soil pipe and cistern flush pipe, use a jigsaw with a fine-toothed blade suitable for timber. Ensure that the room is well ventilated when cutting the material.

All cut edges must be sealed with PVA glue or good-quality, sanitary grade silicone sealant to prevent the ingress of moisture.

Re-fit the lower fascia, followed by the top fascia panel.

It is good practise to run a bead of silicone where the furniture meets the floor and walls.

Care & Maintenance

Furniture should be regularly dusted with a soft cotton or micro-fibre cloth. For more thorough cleaning, occasionally wipe your furniture with a soft cloth dampened with a mild detergent solution. Surfaces should be thoroughly dried with a lint free cloth to prevent watermarks. Under no circumstances should solvent cleaning agents, bleach or abrasive cleaning agents or cloths be used. Spills should be removed immediately using a clean cloth. All bathroom furniture will deteriorate through prolonged periods of exposure to high levels of condensation so bathrooms must be adequately ventilated using suitable extraction. Failure to ensure adequate ventilation may invalidate your guarantee.

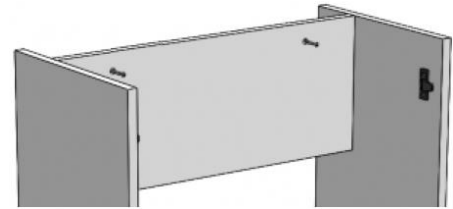

Installation Guide

Qube Glide Tall Storage Unit

Important Information

- Read the instructions carefully.
- Check the product for any signs of damage and remove any protective film.
- It is recommended that a technically competent installer undertakes the installation.
- It is the installer's responsibility to carry out a thorough assessment of the wall type and the weight of the cabinet and use appropriate fixings.
- Care should be taken when drilling walls to avoid any hidden wires or pipes.
- To prevent the cabinet falling down this product must be fixed using the wall attachment device provided.

Installation

It may be necessary to snap the wall plate in half at the marked line to create two wall brackets. Mark a horizontal line on the wall at the required height X--X. Ensure that the wall brackets will fit inside the width of the cabinet and are equally spaced to ensure even distribution of weight. Secure the wall brackets to the wall using suitable fixings.

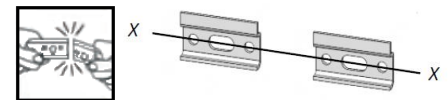

Hook the unit onto the wall brackets ensuring that the brackets are securely located.

To adjust the position of the cabinet on the wall, use the two screws in each hanging bracket. The top screws will move the cabinet closer to or further away from the wall. The lower screws will move the cabinet up and down.

A securing screw should be fitted through the back of the unit through the fixed back rail of the cabinet and into the wall. This will help to stabilise the unit.

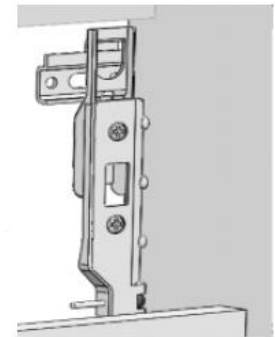

It is good practise to run a bead of silicone where the furniture meets the floor and walls.

Door hinge adjustment

- To square the door against the cabinet, turn screws A until adjusted as required.
- To adjust the door closer to or further away from the cabinet, turn screws B.
- To adjust the door vertically, slacken screws C. Re-tighten once the door is adjusted as required.
- To remove the door hinges from the cabinet, press button D.
- To remove the door hinges from the door, remove screws E.

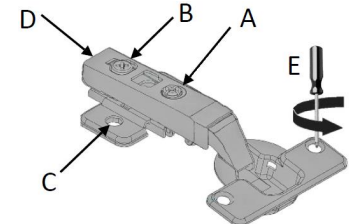

Care & Maintenance

Furniture should be regularly dusted with a soft cotton or micro-fibre cloth. For more thorough cleaning, occasionally wipe your furniture with a soft cloth dampened with a mild detergent solution. Surfaces should be thoroughly dried with a lint free cloth to prevent watermarks. Under no circumstances should solvent cleaning agents, bleach or abrasive cleaning agents or cloths be used. Spills should be removed immediately using a clean cloth. All bathroom furniture will deteriorate through prolonged periods of exposure to high levels of condensation so bathrooms must be adequately ventilated using suitable extraction. Failure to ensure adequate ventilation may invalidate your guarantee.

Installation Guide

Qube Open Shelf Base Unit

Important Information

- Read the instructions carefully.
- Check the product for any signs of damage and remove any protective film.
- It is the installer's responsibility to carry out a thorough assessment of wall type and the weight of the cabinet and use appropriate fixings.
- Care should be taken when drilling walls to avoid any hidden wires or pipes.

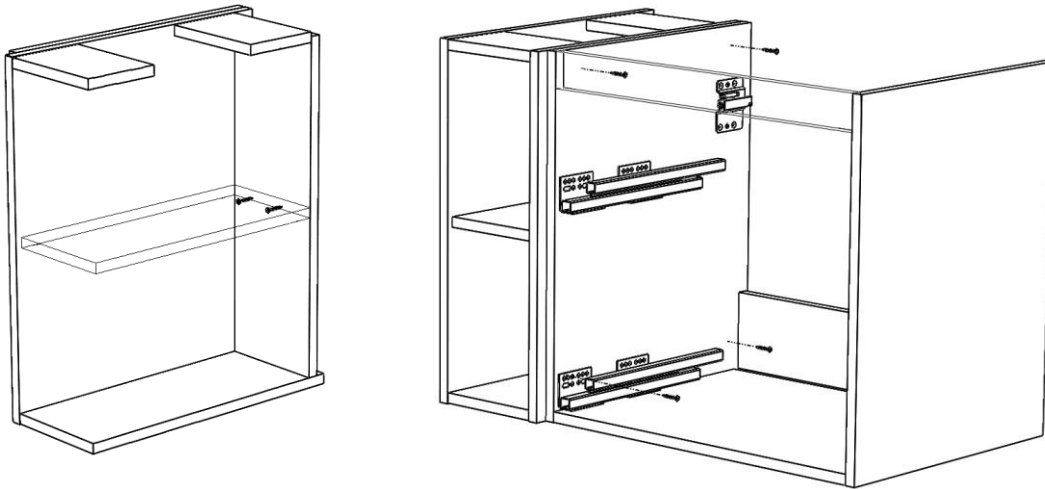

Installation

Secure the cabinet to the wall through the back panel.

Use screws and fixings that are suitable for the wall type and the weight of the cabinet.

Additional screws should be fitted through the gable panels to hold the base open shelf and washbasin units together.

Screw through from the inside of the washbasin unit ensuring that the length of screws is suitable for the thickness of the gables.

It is recommended that the fixings are hidden behind the drawer runners and screwed into the top panels.

It is good practise to run a bead of silicone where the furniture meets the wall.

Care & Maintenance

Furniture should be regularly dusted with a soft cotton or micro-fibre cloth. For more thorough cleaning, occasionally wipe your furniture with a soft cloth dampened with a mild detergent solution. Surfaces should be thoroughly dried with a lint free cloth to prevent watermarks. Under no circumstances should solvent cleaning agents, bleach or abrasive cleaning agents or cloths be used. Spills should be removed immediately using a clean cloth. All bathroom furniture will deteriorate through prolonged periods of exposure to high levels of condensation so bathrooms must be adequately ventilated using suitable extraction. Failure to ensure adequate ventilation may invalidate your guarantee.

Installation Guide

Qube Open Shelf Wall Unit

Important Information

- Read the instructions carefully.
- Check the product for any signs of damage and remove any protective film.
- It is the installer's responsibility to carry out a thorough assessment of wall type and the weight of the cabinet and use appropriate fixings.
- Care should be taken when drilling walls to avoid any hidden wires or pipes.

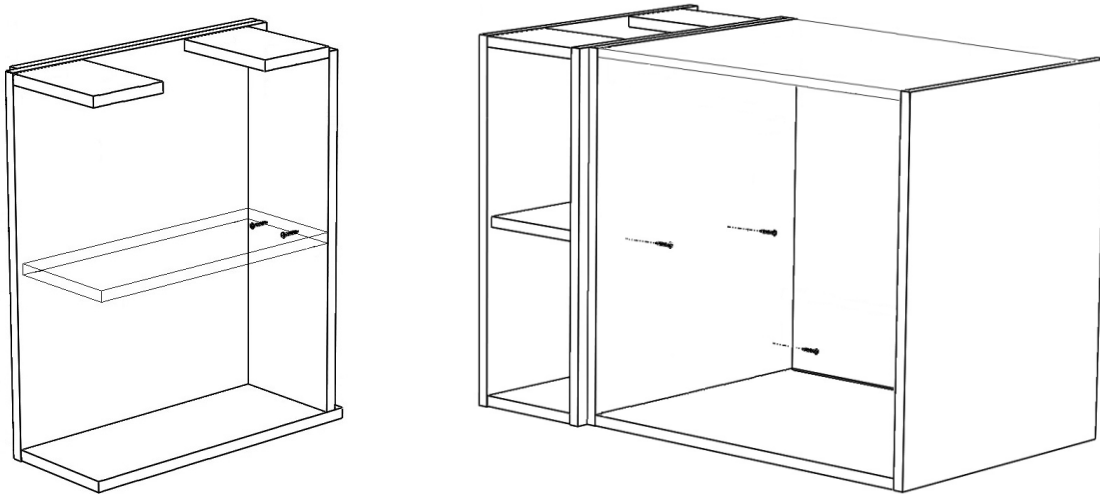

Installation

Secure the cabinet to the wall through the back panel.

Use screws and fixings that are suitable for the wall type and the weight of the cabinet.

Additional screws should be fitted through the gable panels to hold the wall open shelf and mirror cabinet together.

Screw through from the inside of the mirror cabinet.

It is recommended that the fixings are hidden behind the shelves.

It is good practise to run a bead of silicone where the furniture meets the wall.

Care & Maintenance

Furniture should be regularly dusted with a soft cotton or micro-fibre cloth. For more thorough cleaning, occasionally wipe your furniture with a soft cloth dampened with a mild detergent solution. Surfaces should be thoroughly dried with a lint free cloth to prevent watermarks. Under no circumstances should solvent cleaning agents, bleach or abrasive cleaning agents or cloths be used. Spills should be removed immediately using a clean cloth. All bathroom furniture will deteriorate through prolonged periods of exposure to high levels of condensation so bathrooms must be adequately ventilated using suitable extraction. Failure to ensure adequate ventilation may invalidate your guarantee.

Installation Guide

Qube Frameless Mirror

Important Information

- Read the instructions carefully.
- Check the product for any signs of damage and remove any protective film.
- It is recommended that a technically competent installer undertakes the installation.
- It is the installer's responsibility to carry out a thorough assessment of the wall type and the weight of the product and use appropriate fixings.
- Care should be taken when drilling walls to avoid any hidden wires or pipes.

Installation

Push the plastic inserts into the rear of the mirror panel.

Note: the mirror can be fitted portrait or landscape.

Ensure that the inserts are aligned in the correct direction.
Once the inserts have been fitted, they cannot be removed.

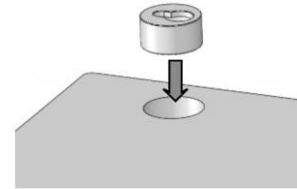

Mark the wall to suit the distance between the centres of the inserts.

Drill the wall and secure the fixings (not supplied) at the marked positions.

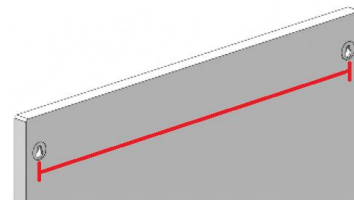

Note: you must ensure that the fixings are suitable for the weight of the mirror and the wall type.

Hang the mirror onto the wall fixings, ensuring that they are located securely into the inserts.

Care & Maintenance

Furniture should be regularly dusted with a soft cotton or micro-fibre cloth. For more thorough cleaning, occasionally wipe your furniture with a soft cloth dampened with a mild detergent solution. Surfaces should be thoroughly dried with a lint free cloth to prevent watermarks. Under no circumstances should solvent cleaning agents, bleach or abrasive cleaning agents or cloths be used. Glass or mirrored panels should be cleaned using a non-solvent based glass cleaner and a soft cloth. Spills should be removed immediately using a clean cloth. All bathroom furniture will deteriorate through prolonged periods of exposure to high levels of condensation so bathrooms must be adequately ventilated using suitable extraction. Failure to ensure adequate ventilation may invalidate your guarantee.

Important Information

- Read the instructions carefully.
- Check the product for any signs of damage and remove any protective film.
- It is recommended that this product is fitted by a suitably qualified Part P registered electrician in accordance with current IEE & Building Regulations.
- It is the installer's responsibility to carry out a thorough assessment of wall type and the weight of the cabinet and use appropriate fixings.
- Care should be taken when drilling walls to avoid any hidden wires or pipes.
- To prevent the cabinet falling down this product must be fixed using the wall attachment device provided.
- The terminal block used to connect the leads to the electrical supply can be of either the screw- or screw-less type and should be rated at 240V 6A with 4 terminals. The cable tails do not need to be crimped when connected to the terminal block.
- The driver can be screwed to the internal top rail of the cabinet or left to hang in the void between the cabinet and the wall.
- This product should be used only with mains supply that is protected by a 30mA Residual Current Device.

Connection to Mains Electrics

1. Turn off the electrical supply.
2. Connect the electrical supply in the bathroom to the shaver socket transformer cable (A). It is recommended that the shaver socket is connected to a constant feed. Connect the push-fit cable from the shaver socket transformer to the cable from the rear of the shaver socket.
3. Turn the electrical supply back on and check that the shaver socket functions as required.

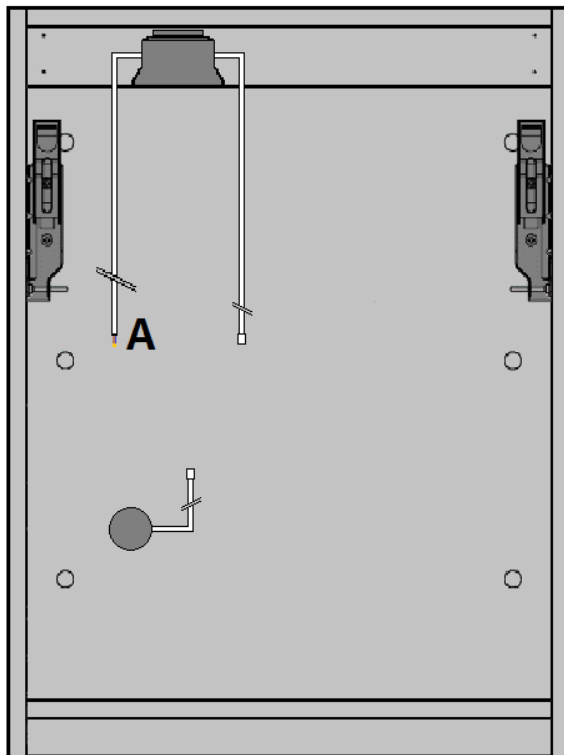

WARNING RISK OF ELECTRIC SHOCK

Turn off Mains Electric prior to commencing work.

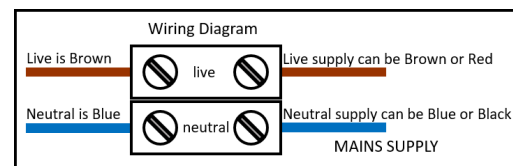

Bathroom Lighting Zones

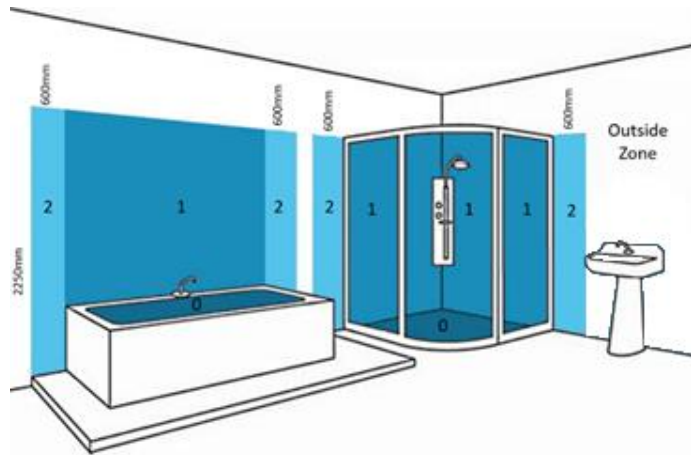

Fitting Cabinet to Wall

It may be necessary to snap the wall plate in half at the marked line to create two wall brackets. Mark a horizontal line on the wall at the required height X---X. Ensure that the wall brackets will fit inside the width of the cabinet and are equally spaced to ensure even distribution of weight. Secure the wall brackets to the wall using suitable fixings.

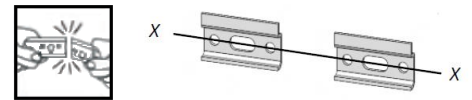

Hook the unit onto the wall brackets ensuring that the brackets are securely located.

To alter the position of the cabinet on the wall, adjust the two screws in each hanging bracket. The top screws will move the cabinet closer to or further away from the wall. The lower screws will move the cabinet up and down.

A securing screw should be fitted through the back of the unit through the fixed back of the cabinet and into the wall, this will help to stabilise the unit.

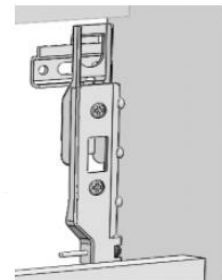

Door hinge adjustment

- To square the door against the cabinet, turn screws A until adjusted as required.
- To adjust the door closer to or further away from the cabinet, turn screws B.
- To adjust the door vertically, slacken screws C. Re-tighten once the door is adjusted as required.
- To remove the door hinges from the cabinet, press button D.
- To remove the door hinges from the door, remove screws E.

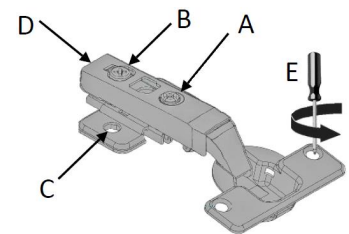

Care & Maintenance

Furniture should be regularly dusted with a soft cotton or micro-fibre cloth. For more thorough cleaning, occasionally wipe your furniture with a soft cloth dampened with a mild detergent solution. Surfaces should be thoroughly dried with a lint free cloth to prevent watermarks. Under no circumstances should solvent cleaning agents, bleach or abrasive cleaning agents or cloths be used. Glass or mirrored panels should be cleaned using a non-solvent based glass cleaner and a soft cloth. Spills should be removed immediately using a clean cloth. All bathroom furniture will deteriorate through prolonged periods of exposure to high levels of condensation so bathrooms must be adequately ventilated using suitable extraction. Failure to ensure adequate ventilation may invalidate your guarantee.

Installation Guide

Qube Mirror Cabinet

Important Information

- Read the instructions carefully.
- Check the product for any signs of damage and remove any protective film.
- It is the installer's responsibility to carry out a thorough assessment of wall type and the weight of the cabinet and use appropriate fixings.
- Care should be taken when drilling walls to avoid any hidden wires or pipes.
- To prevent the cabinet falling down this product must be fixed using the wall attachment device provided.

Installation

Remove the doors from the cabinet. It may be necessary to snap the wall plate in half at the marked line to create two wall brackets. Mark a horizontal line on the wall at the required height X---X. Ensure that the wall brackets will fit inside the width of the cabinet and are equally spaced to ensure even distribution of weight. Secure the wall brackets to the wall using suitable fixings.

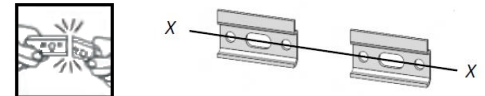

Hook the unit onto the wall brackets ensuring that the brackets are securely located.

To alter the position of the cabinet on the wall, adjust the two screws in each hanging bracket. The top screws will move the cabinet closer to or further away from the wall. The lower screws will move the cabinet up and down.

If this cabinet is being fitted in a run, secure the units together with suitable fixings through the gables. Try to hide the fixings where possible behind shelves or hinge plates.

A securing screw should be fitted through the back of the unit through the fixed back of the cabinet and into the wall, this will help to stabilise the unit.

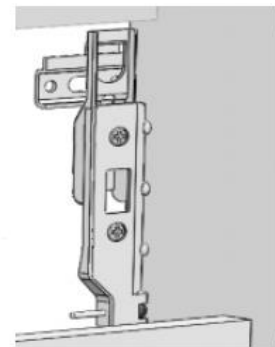

Door hinge adjustment

- To square the door against the cabinet, adjust screws A.
- To adjust the door closer to or further away from the cabinet, adjust screws B.
- To adjust the door vertically, slacken screws C. Re-tighten once the door is adjusted as required.
- To remove the door hinges from the cabinet, press button D.
- To remove the door hinges from the door, remove screws E.

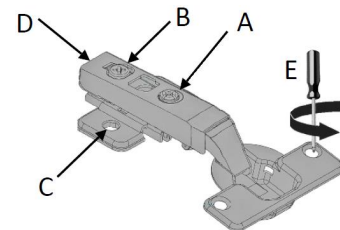

Care & Maintenance

Furniture should be regularly dusted with a soft cotton or micro-fibre cloth. For more thorough cleaning, occasionally wipe your furniture with a soft cloth dampened with a mild detergent solution. Surfaces should be thoroughly dried with a lint free cloth to prevent watermarks. Under no circumstances should solvent cleaning agents, bleach or abrasive cleaning agents or cloths be used. Spills should be removed immediately using a clean cloth. All bathroom furniture will deteriorate through prolonged periods of exposure to high levels of condensation so bathrooms must be adequately ventilated using suitable extraction. Failure to ensure adequate ventilation may invalidate your guarantee.

Installation Guide

Qube Bath Side Panel



Bathroom Perfection

Important Information

- Read the instructions carefully.
- Check the product for any signs of damage and remove any protective film.
- It is recommended that a technically competent installer undertakes the installation.
- It is the installer's responsibility to carry out a thorough assessment of the wall type and use appropriate fixings.
- Care should be taken when drilling walls to avoid any hidden wires or pipes.

Installation

Set the height of the bath to suit the height of the bath panel according to the instructions supplied with the bath. Ensure that when the brackets and bath panel are fitted, the panel sits 4mm proud of the bath rim.

If you are installing this side panel in conjunction with an end panel, fit the end panel first according to the instructions supplied with it.

Screw three black Keku clips to the underside of the wooden batten underneath the bath rim using the screws provided. The three clips should be equally spaced along the length of the bath. Use the diagram as a guide to how the Keku clips are fitted.

The matching Keku clips should be screwed to the rear of the bath panel using the screws supplied. Measure carefully to ensure that the clips on the rear of the bath panel will engage with the clips screwed to the bath.

If the bath panel is being fitted between two walls, the two "L" brackets should be secured to the walls to prevent the panel from being pushed inwards. Ensure suitable fixings are used.

If the bath panel is being used in conjunction with an end panel, secure one "L" bracket to the wall to prevent the panel from being pushed inwards. On the opposite side to the wall, secure the bath panel in place using a Keku clip. This Keku clip is supplied with the end panel, along with instruction on how it is fitted.

Once fully installed, seal around the bath panel on all joints using a good quality, sanitary-grade silicone sealant.

Care & Maintenance

Furniture should be regularly dusted with a soft cotton or micro-fibre cloth. For more thorough cleaning, occasionally wipe your furniture with a soft cloth dampened with a mild detergent solution. Surfaces should be thoroughly dried with a lint free cloth to prevent watermarks. Under no circumstances should solvent cleaning agents, bleach or abrasive cleaning agents or cloths be used. Spills should be removed immediately using a clean cloth. All bathroom furniture will deteriorate through prolonged periods of exposure to high levels of condensation so bathrooms must be adequately ventilated using suitable extraction. Failure to ensure adequate ventilation may invalidate your guarantee.

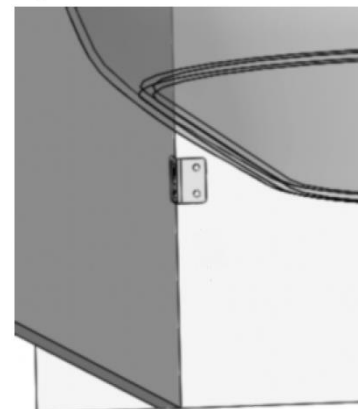
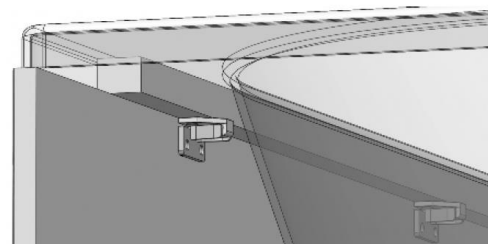

Installation Guide

Qube Bath End Panel



Bathroom Perfection

Important Information

- Read the instructions carefully.
- Ensure product contents are complete.
- Check the product for any signs of damage and remove any protective film.
- It is recommended that a technically competent installer undertakes the installation.
- It is the installer's responsibility to carry out a thorough assessment of the wall type and use appropriate fixings.
- Care should be taken when drilling to avoid any hidden wires or pipes.

Installation

Set the height of the bath to suit the height of the bath panel according to the instructions supplied with the bath

Fit the end panel before installing the side panel

Ensure that when the brackets and bath panel are fitted, the panel sits 4mm proud of the bath rim.

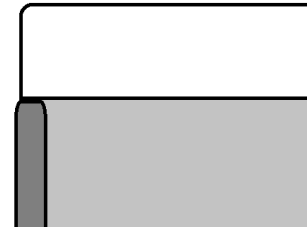

Secure one "L" bracket to the wall using suitable fixings. It is recommended that the bracket is fitted 300mm vertically from the underside of the bath.

Secure the second "L" bracket to the underside of the wooden batten under the bath rim using the screws provided.

Screw one of the black Keku clips to the opposite side of the end panel to the wall. The matching Keku clip should be screwed to the back of the front panel. Use the diagram as a guide to how these are fitted.

Once fully installed, seal around the bath panel on all joints using a good quality, sanitary-grade silicone sealant.

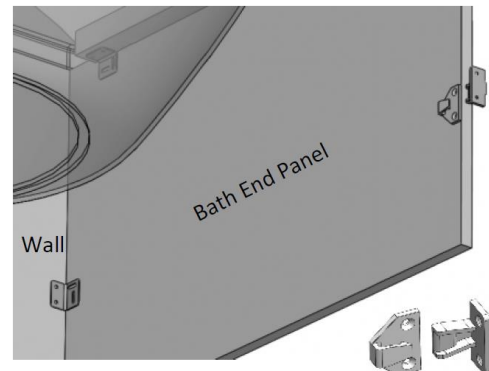

Care & Maintenance

Furniture should be regularly dusted with a soft cotton or micro-fibre cloth. For more thorough cleaning, occasionally wipe your furniture with a soft cloth dampened with a mild detergent solution. Surfaces should be thoroughly dried with a lint free cloth to prevent watermarks. Under no circumstances should solvent cleaning agents, bleach or abrasive cleaning agents or cloths be used. Glass or mirrored panels should be cleaned using a non-solvent based glass cleaner and a soft cloth. Spills should be removed immediately using a clean cloth. All bathroom furniture will deteriorate through prolonged periods of exposure to high levels of condensation so bathrooms must be adequately ventilated using suitable extraction. Failure to ensure adequate ventilation may invalidate your guarantee.