

Installation Guide

Qube Fitted Semi-Recessed Washbasin Unit

Important Information

- Read the instructions carefully.
- Check the product for any signs of damage and remove any protective film.
- It is recommended that a technically competent installer undertakes installation.
- It is the installer's responsibility to carry out a thorough assessment of the wall type and the weight of the cabinet and use appropriate fixings.
- Care should be taken when drilling walls to avoid any hidden wires or pipes.
- If the fascias are to be cut, use a saw with a fine-toothed blade ensuring that the room is well ventilated. Any cut edges should be sealed with PVA glue or silicone sealant to prevent the ingress of moisture.

Installation

Remove the fascia panel by pulling it away from the unit. Remove the doors and shelf and turn the unit upside down. Push the legs firmly into the leg sockets.

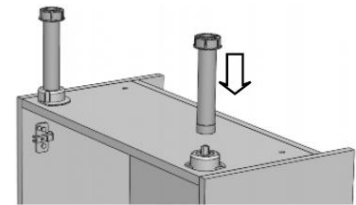

Stand the unit back on its legs against the wall. If fitting a run of units, fix them together through the gable panels. Try to hide the fixings where possible behind shelves or hinge plates.

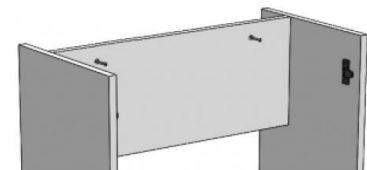

Adjust the legs on the units until they are level. Secure the units to the wall by drilling through the back rail and using suitable fixings for the wall type.

It is good practise to run a bead of silicone where the furniture meets the floor and walls.

Re-fit the shelf and doors and push the fascia panel back into place.

Door hinge adjustment

- To square the door against the cabinet, adjust screws A.
- To adjust the door closer to or further away from the cabinet, adjust screws B.
- To adjust the door vertically, slacken screws C. Re-tighten once the door is adjusted as required.
- To remove the door hinges from the cabinet, press button D.
- To remove the door hinges from the door, remove screws E.

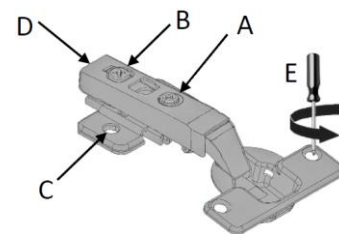

Care & Maintenance

Furniture should be regularly dusted with a soft cotton or micro-fibre cloth. For more thorough cleaning, occasionally wipe your furniture with a soft cloth dampened with a mild detergent solution. Surfaces should be thoroughly dried with a lint free cloth to prevent watermarks. Under no circumstances should solvent cleaning agents, bleach or abrasive cleaning agents or cloths be used. Spills should be removed immediately using a clean cloth. All bathroom furniture will deteriorate through prolonged periods of exposure to high levels of condensation so bathrooms must be adequately ventilated using suitable extraction. Failure to ensure adequate ventilation may invalidate your guarantee.

Installation Guide

Qube Fitted Back-To-Wall Toilet Unit

Important Information

- Read the instructions carefully.
- Check the product for any signs of damage and remove any protective film.
- It is recommended that a technically competent installer undertakes installation.
- It is the installer's responsibility to carry out a thorough assessment of the wall type and the weight of the cabinet and use appropriate fixings.
- Care should be taken when drilling walls to avoid any hidden wires or pipes.
- If the fascias are to be cut, use a saw with a fine-toothed blade ensuring that the room is well ventilated. Any cut edges should be sealed with PVA glue or silicone sealant to prevent the ingress of moisture.

Installation

Remove the top fascia panel first by pulling it away from the cabinet. Remove the lower fascia by lifting it upwards. Turn the unit upside down. Push the legs firmly into the leg sockets.

Stand the unit back on its legs against the wall. If fitting a run of units, fix them together through the gable panels. Try to hide the fixings where possible behind shelves or hinge plates. Adjust the legs on the units until they are level.

To secure the toilet unit against the wall, screw the stretcher plates to the gables of the cabinet. Ensure that the screws used are suitable for the thickness of the cabinet.

Mark the position of the holes in the stretcher plates on the wall. Drill the positions marked with a suitable drill bit. Fasten the unit in position through the stretcher plates using fixings suitable for the wall type.

Replace the panels on the toilet unit, fitting the lower fascia first.

If you are fitting a toilet unit to a run of units, the plinth should end at the gable of the toilet unit. Screw an offcut to the end of the plinth to finish the joint between the lower fascia panel and the plinth. Fit the plinth to the legs using the clips and screws provided.

It is good practise to run a bead of silicone where the furniture meets the floor and walls.

Care & Maintenance

Furniture should be regularly dusted with a soft cotton or micro-fibre cloth. For more thorough cleaning, occasionally wipe your furniture with a soft cloth dampened with a mild detergent solution. Surfaces should be thoroughly dried with a lint free cloth to prevent watermarks. Under no circumstances should solvent cleaning agents, bleach or abrasive cleaning agents or cloths be used. Spills should be removed immediately using a clean cloth. All bathroom furniture will deteriorate through prolonged periods of exposure to high levels of condensation so bathrooms must be adequately ventilated using suitable extraction. Failure to ensure adequate ventilation may invalidate your guarantee.

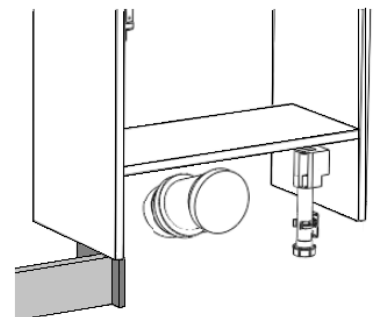
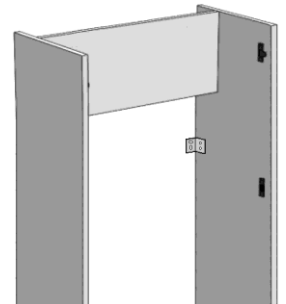
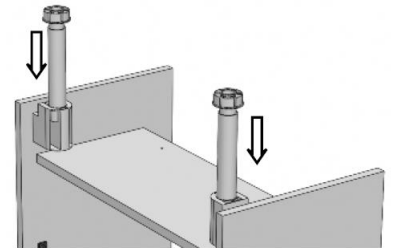

Installation Guide

Qube Fitted Single Base Unit

Please leave these instructions with the end user.

Important Information

- Read the instructions carefully.
- Check the product for any signs of damage and remove any protective film.
- It is recommended that a technically competent installer undertakes installation.
- It is the installer's responsibility to carry out a thorough assessment of the wall type and the weight of the cabinet and use appropriate fixings.
- Care should be taken when drilling walls to avoid any hidden wires or pipes.

Installation

Remove the door and shelf, turn the unit upside down and push the legs firmly into the leg sockets.

Stand the unit back on its legs against the wall. If fitting a run of units, fix them together through the gable panels. Where possible, try to hide the fixings behind shelves or hinge plates.

Adjust the legs on the units until they are level.

Secure the unit to the wall by drilling through the back rail and using suitable fixings for the wall type.

It is good practise to run a bead of silicone where the furniture meets the floor and walls.

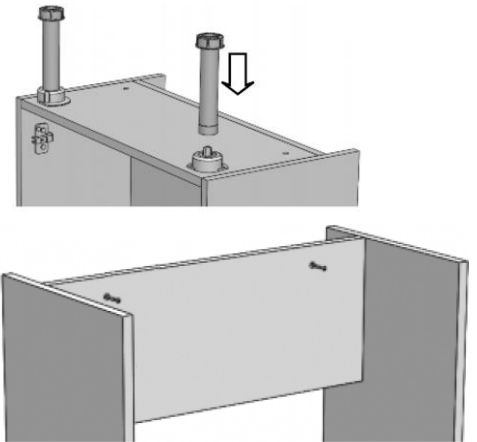

Door hinge adjustment

- To square the door against the cabinet, adjust screws A.
- To adjust the door closer to or further away from the cabinet, adjust screws B.
- To adjust the door vertically, slacken screws C. Re-tighten once the door is adjusted as required.
- To remove the door hinges from the cabinet, press button D.
- To remove the door hinges from the door, remove screws E.

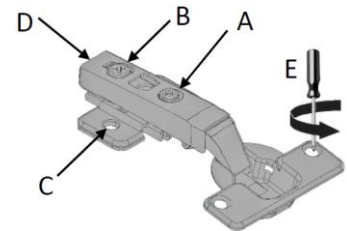

Care & Maintenance

Furniture should be regularly dusted with a soft cotton or micro-fibre cloth. For more thorough cleaning, occasionally wipe your furniture with a soft cloth dampened with a mild detergent solution. Surfaces should be thoroughly dried with a lint free cloth to prevent watermarks. Under no circumstances should solvent cleaning agents, bleach or abrasive cleaning agents or cloths be used. Spills should be removed immediately using a clean cloth. All bathroom furniture will deteriorate through prolonged periods of exposure to high levels of condensation so bathrooms must be adequately ventilated using suitable extraction. Failure to ensure adequate ventilation may invalidate your guarantee.

Installation Guide

Qube Fitted Laminate Worktop

Important Information

- Read the instructions carefully.
- Check the product for any signs of damage and remove any protective film.
- It is recommended that a technically competent installer undertakes installation.
- Care should be taken when drilling walls to avoid any hidden wires or pipes.
- If this product is to be cut, ensure that the correct Personal Protective Equipment is used and that the room is well ventilated. Any cut edges must be sealed with good quality silicone sealant or PVA glue to prevent water ingress.

Installation

It is recommended that the doors, drawer fronts and fascia panels are removed from the cabinets when fitting a worktop to avoid any potential damage. If the worktop has become slightly bowed due to incorrect storage, it can be pulled straight during the installation process.

Position the worktop on the units and push it up against the wall to enable you to mark and measure for cutting. If the worktop is to be scribed to the wall, do so using a compass and pencil.



We suggest that an allowance of 10mm is made to accommodate a worktop overhang on an exposed worktop or show ends. Use a belt sander to remove the final material and to avoid saw chips. If necessary, hand finish the cut edge using a suitable grade of sandpaper.

Secure the worktop to the units from underneath using screws of the correct length (not supplied). Stretcher plates (not supplied) can also be used if required.

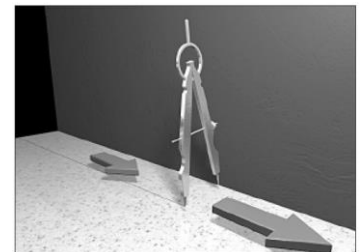

If the worktop is to be cut to install a semi-recessed basin, use the template supplied with the basin as a guide.

To finish, run a bead of silicone between the joint of the worktop and the wall. Allow 24 hours to allow the silicone to cure fully.

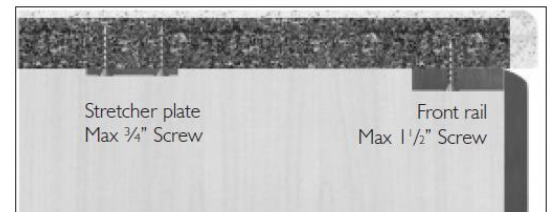

Care & Maintenance

Furniture should be regularly dusted with a soft cotton or micro-fibre cloth. For more thorough cleaning, occasionally wipe your furniture with a soft cloth dampened with a mild detergent solution. Surfaces should be thoroughly dried with a lint free cloth to prevent watermarks. Under no circumstances should solvent cleaning agents, bleach or abrasive cleaning agents or cloths be used. Spills should be removed immediately using a clean cloth. All bathroom furniture will deteriorate through prolonged periods of exposure to high levels of condensation so bathrooms must be adequately ventilated using suitable extraction. Failure to ensure adequate ventilation may invalidate your guarantee.

Installation Guide

Qube Fitted Bath Side Panel

Important Information

- Read the instructions carefully.
- Check the product for any signs of damage and remove any protective film.
- It is recommended that a technically competent installer undertakes installation.
- It is the installer's responsibility to carry out a thorough assessment of the wall type and use appropriate fixings.
- Care should be taken when drilling walls to avoid any hidden wires or pipes.

Installation

Set the height of the bath to suit the height of the bath panel according to the instructions supplied with the bath.

Ensure that when the brackets and bath panel are fitted, the panel sits 4mm proud of the bath rim.

If you are installing this side panel in conjunction with an end panel, fit the end panel first according to the instructions supplied with it.

Screw three black Keku clips to the underside of the wooden batten underneath the bath rim using the screws provided. The three clips should be equally spaced along the length of the bath. Use the diagram as a guide to how the Keku clips are fitted.

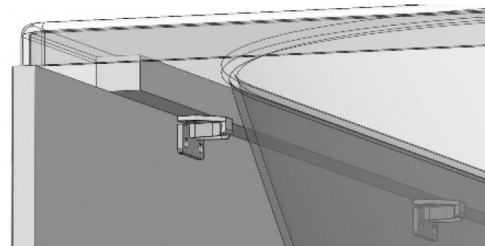

The matching Keku clips should be screwed to the rear of the bath panel using the screws supplied. Measure carefully to ensure that the clips on the rear of the bath panel will engage with the clips screwed to the bath.

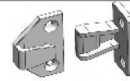

If the bath panel is being fitted between two walls, the two "L" brackets should be secured to the walls to prevent the panel from being pushed inwards. Ensure suitable fixings are used.

If the bath panel is being used in conjunction with an end panel, secure one "L" bracket to the wall to prevent the panel from being pushed inwards. On the opposite side to the wall, secure the bath panel in place using a Keku clip. This Keku clip is supplied with the end panel, along with instruction on how it is fitted.

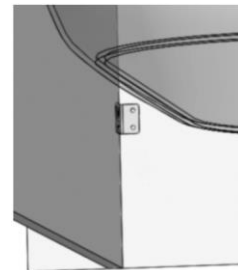

Once fully installed, seal around the bath panel on all joints using a good quality, sanitary-grade silicone sealant.

Care & Maintenance

Furniture should be regularly dusted with a soft cotton or micro-fibre cloth. For more thorough cleaning, occasionally wipe your furniture with a soft cloth dampened with a mild detergent solution. Surfaces should be thoroughly dried with a lint free cloth to prevent watermarks. Under no circumstances should solvent cleaning agents, bleach or abrasive cleaning agents or cloths be used. Glass or mirrored panels should be cleaned using a non-solvent based glass cleaner and a soft cloth. Spills should be removed immediately using a clean cloth. All bathroom furniture will deteriorate through prolonged periods of exposure to high levels of condensation so bathrooms must be adequately ventilated using suitable extraction. Failure to ensure adequate ventilation may invalidate your guarantee.

Installation Guide

Qube Fitted Bath End Panel

Important Information

- Read the instructions carefully.
- Ensure product contents are complete.
- Check the product for any signs of damage and remove any protective film.
- It is recommended that a technically competent installer undertakes installation.
- It is the installer's responsibility to carry out a thorough assessment of the wall type and use appropriate fixings.
- Care should be taken when drilling to avoid any hidden wires or pipes.

Installation

Set the height of the bath to suit the height of the bath panel according to the instructions supplied with the bath

Fit the end panel before installing the side panel

Ensure that when the brackets and bath panel are fitted, the panel sits 4mm proud of the bath rim.



Secure one "L" bracket to the wall using suitable fixings. It is recommended that the bracket is fitted 300mm vertically from the underside of the bath.

Secure the second "L" bracket to the underside of the wooden batten under the bath rim using the screws provided.

Screw one of the black Keku clips to the opposite side of the end panel to the wall. The matching Keku clip should be screwed to the back of the front panel. Use the diagram as a guide to how these are fitted.

Once fully installed, seal around the bath panel on all joints using a good quality, sanitary-grade silicone sealant.

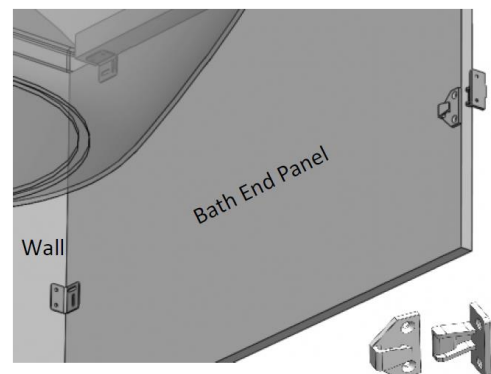

Care & Maintenance

Furniture should be regularly dusted with a soft cotton or micro-fibre cloth. For more thorough cleaning, occasionally wipe your furniture with a soft cloth dampened with a mild detergent solution. Surfaces should be thoroughly dried with a lint free cloth to prevent watermarks. Under no circumstances should solvent cleaning agents, bleach or abrasive cleaning agents or cloths be used. Glass or mirrored panels should be cleaned using a non-solvent based glass cleaner and a soft cloth. Spills should be removed immediately using a clean cloth. All bathroom furniture will deteriorate through prolonged periods of exposure to high levels of condensation so bathrooms must be adequately ventilated using suitable extraction. Failure to ensure adequate ventilation may invalidate your guarantee.