

**CHIC | 500MM CLOAKROOM UNIT – PULL**

**CHC001/\*\*\*, CHC002/\*\*\***

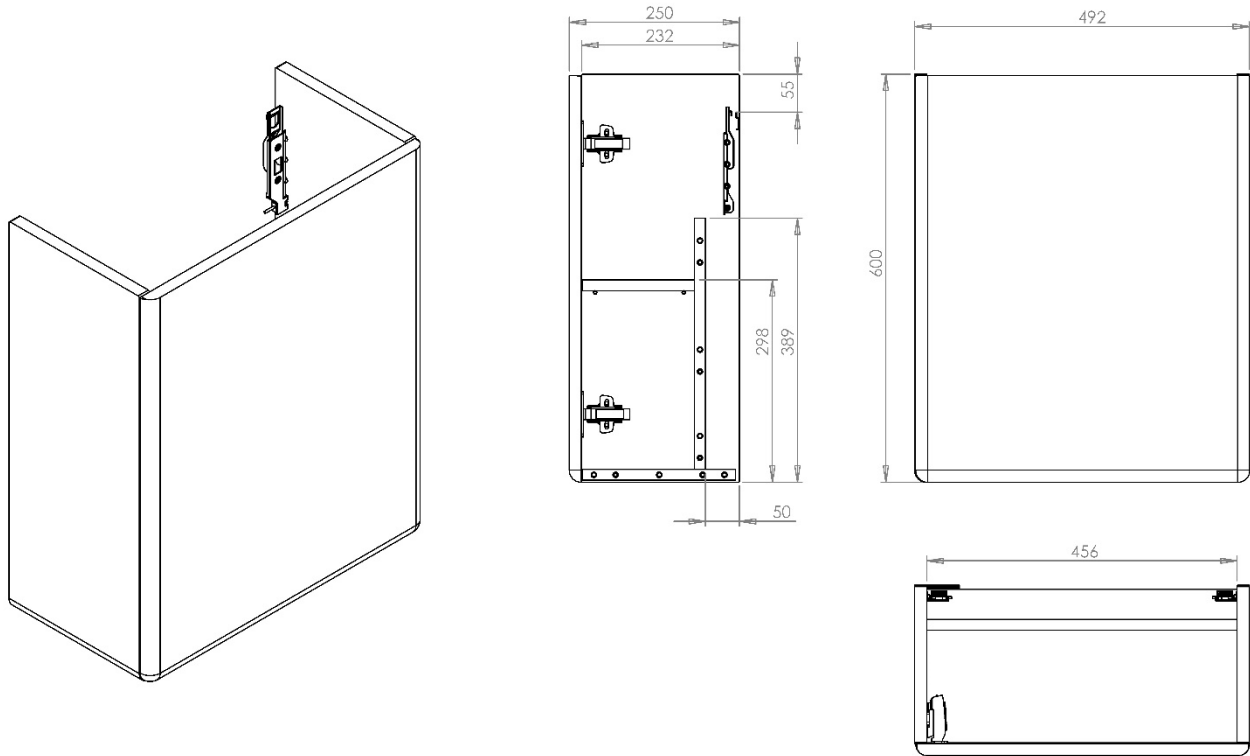

All dimension in mm. Please check dimensions prior to installation as they can vary due to manufacturing tolerances.

**Product Details**

Type:	Cloakroom Washbasin Unit
Width:	500
Depth:	250
Height:	600
Product Weight*:	14.588kg
Tolerances:	+/- 2mm
Guarantee Period:	5 Years (For Domestic Use) 1 Years (For Commercial Use)
Drawer Box Capacity:	N/A

**Product Specification**

Fascia Material:	18mm MDF
Carcass Material:	18mm MDF/16mm MFC
Available accessories:	Please refer to the Pricelist for further details
Opening Mechanism:	Pull Handle
Adjustable Legs:	N/A
Quantity of Shelves:	1 Plus Base
Shelving Type:	MFC
Handing:	Available Left or Right Hand

\*Product Weight includes packaging.

**Features**

- FSC Certified
- Soft Close
- Assembled

**Additional Documentation**

Additional Documentation available on our website [www.utopiagroup.com](http://www.utopiagroup.com)

Every effort has been made to ensure that the information provided on this document is correct at the time of creation. Finally, Utopia Furniture Ltd reserve the right to alter materials and specifications in line with continuing programme of production and service development.

**CHIC | 500MM CLOAKROOM UNIT - P2OPEN\***

CHC003/\*\*\*, CHC004/\*\*\*

**\*Push to Open**

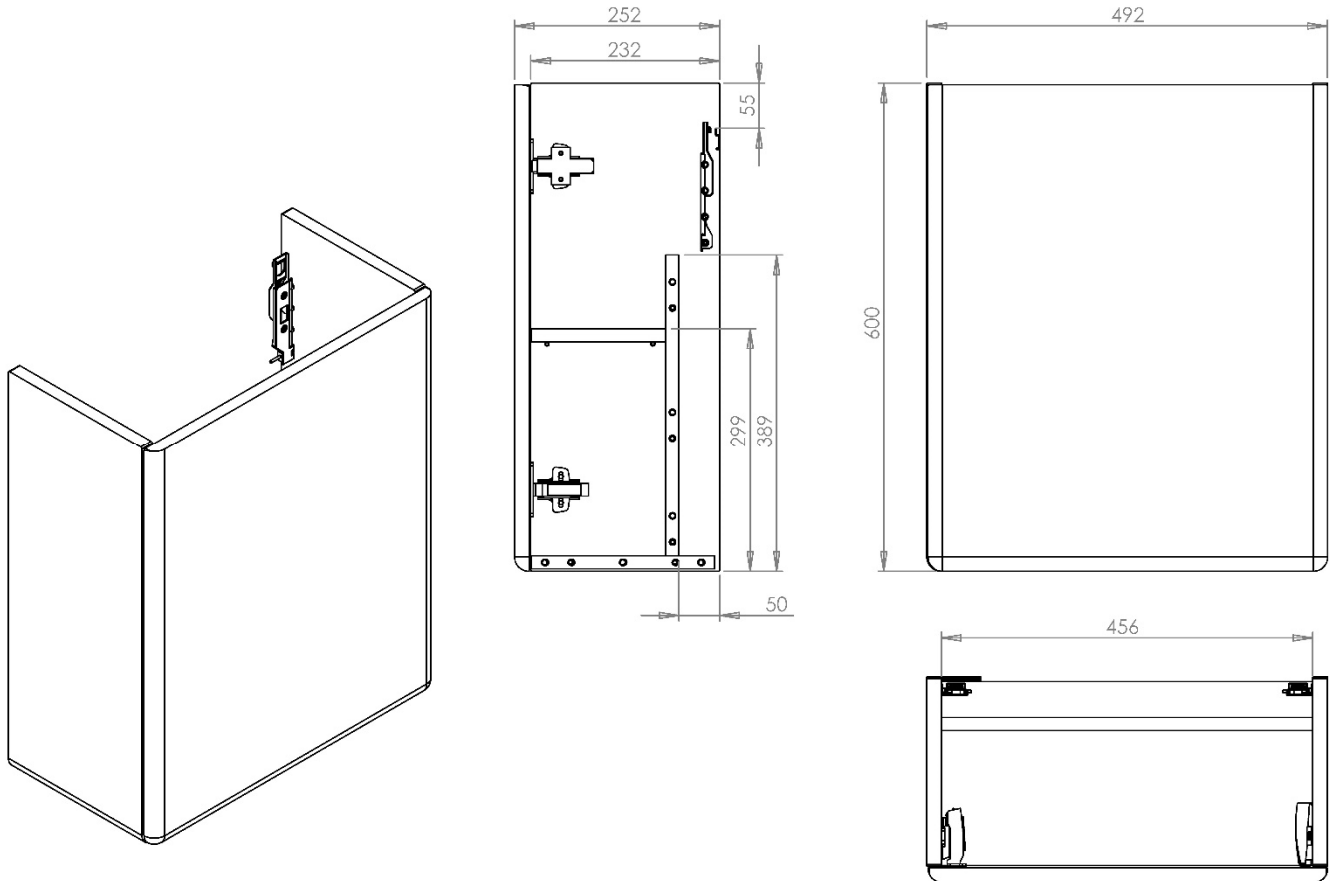

All dimension in mm. Please check dimensions prior to installation as they can vary due to manufacturing tolerances.

**Product Details**

**Product Specification**

Type:	Cloakroom Washbasin Unit
Width:	500
Depth:	252
Height:	600
Product Weight*:	14.588kg
EAN Code:	Available on request
Tolerances:	+/- 2mm
Guarantee Period:	5 Years (For Domestic Use) 1 Years (For Commercial Use)
Drawer Box Capacity:	N/A

Fascia Material:	18mm MDF
Carcass Material:	18mm MDF/16mm MFC
Available accessories:	Please refer to the Pricelist for further details
Opening Mechanism:	Push to Open
Adjustable Legs:	N/A
Quantity of Shelves:	1 Plus Base
Shelving Type:	MFC
Handing:	Available Left or Right Hand

\*Product Weight includes packaging.

**Features**

- FSC Certified
- Soft Close
- Assembled
- Handleless
- Push to Open

**Additional Documentation**

Additional Documentation available on our website [www.utopiagroup.com](http://www.utopiagroup.com)

Every effort has been made to ensure that the information provided on this document is correct at the time of creation. Finally, Utopia Furniture Ltd reserve the right to alter materials and specifications in line with continuing programme of production and service development.

**CHIC | 600 WM SINGLE DRAWER WBU FOR SLABTOP BASIN - PULL**

CHC005/\*\*\*

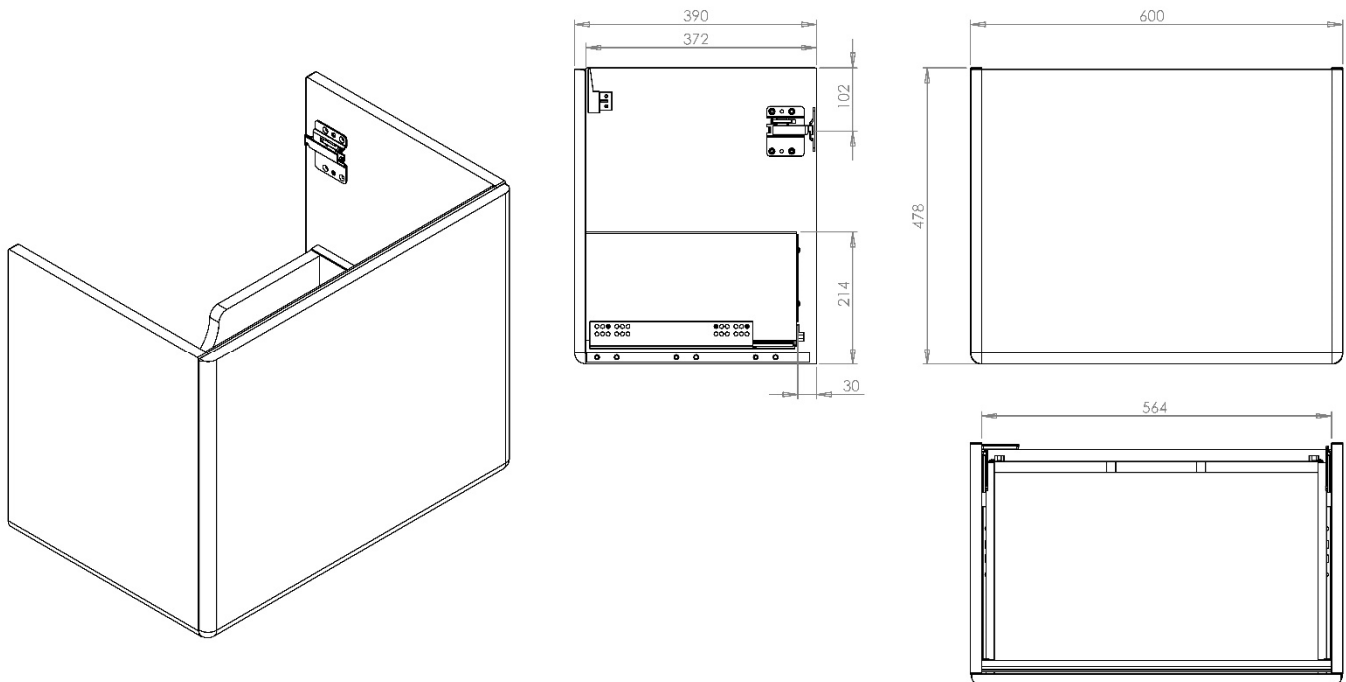

All dimension in mm. Please check dimensions prior to installation as they can vary due to manufacturing tolerances.

**Product Details**

Type:	Single Drawer Washbasin Unit
Width:	600
Depth:	390
Height:	478
Product Weight*:	20.80kg
Tolerances:	+/- 2mm
Guarantee Period:	5 Years (For Domestic Use) 1 Years (For Commercial Use)
Drawer Box Capacity:	30kg

**Product Specification**

Fascia Material:	18mm MDF
Carcass Material:	18mm MDF/16mm MFC
Available accessories:	Please refer to the Pricelist for further details
Opening Mechanism:	Pull Handle
Adjustable Legs:	N/A
Quantity of Shelves:	N/A
Shelving Type:	N/A
Handing:	N/A

\*Product Weight includes packaging.

**Features**

- FSC Certified
- Soft Close
- Assembled

**Additional Documentation**

Additional Documentation available on our website [www.utopiagroup.com](http://www.utopiagroup.com)

Every effort has been made to ensure that the information provided on this document is correct at the time of creation. Finally, Utopia Furniture Ltd reserve the right to alter materials and specifications in line with continuing programme of production and service development.

**CHIC | 600 WM SINGLE DRAWER WBU FOR SLABTOP BASIN - P2Open\***

CHC006/\*\*\*

\*Push to Open

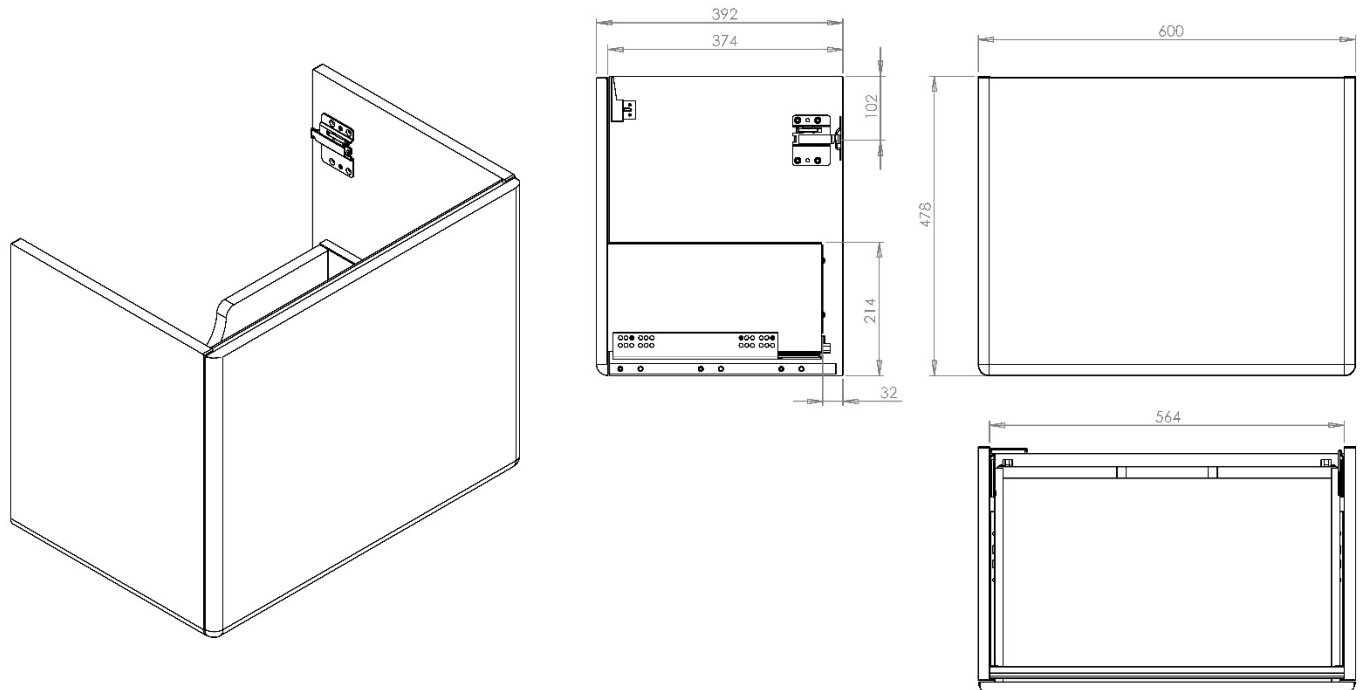

All dimension in mm. Please check dimensions prior to installation as they can vary due to manufacturing tolerances.

**Product Details**

**Product Specification**

Type:	Single Drawer Washbasin Unit
Width:	600
Depth:	392
Height:	478
Product Weight*:	20.80kg
Tolerances:	+/- 2mm
Guarantee Period:	5 Years (For Domestic Use) 1 Years (For Commercial Use)
Drawer Box Capacity:	30kg

Fascia Material:	18mm MDF
Carcass Material:	18mm MDF/16mm MFC
Available accessories:	Please refer to the Pricelist for further details
Opening Mechanism:	Push to Open
Adjustable Legs:	N/A
Quantity of Shelves:	N/A
Shelving Type:	N/A
Handing:	N/A

\*Product Weight includes packaging.

**Features**

- FSC Certified
- Soft Close
- Assembled
- Handleless
- Push to Open

**Additional Documentation**

Additional Documentation available on our website [www.utopiagroup.com](http://www.utopiagroup.com)

Every effort has been made to ensure that the information provided on this document is correct at the time of creation. Finally, Utopia Furniture Ltd reserve the right to alter materials and specifications in line with continuing programme of production and service development.

**CHIC | 800 WM SINGLE DRAWER WBU FOR SLABTOP BASIN - PULL**

CHC007/\*\*\*

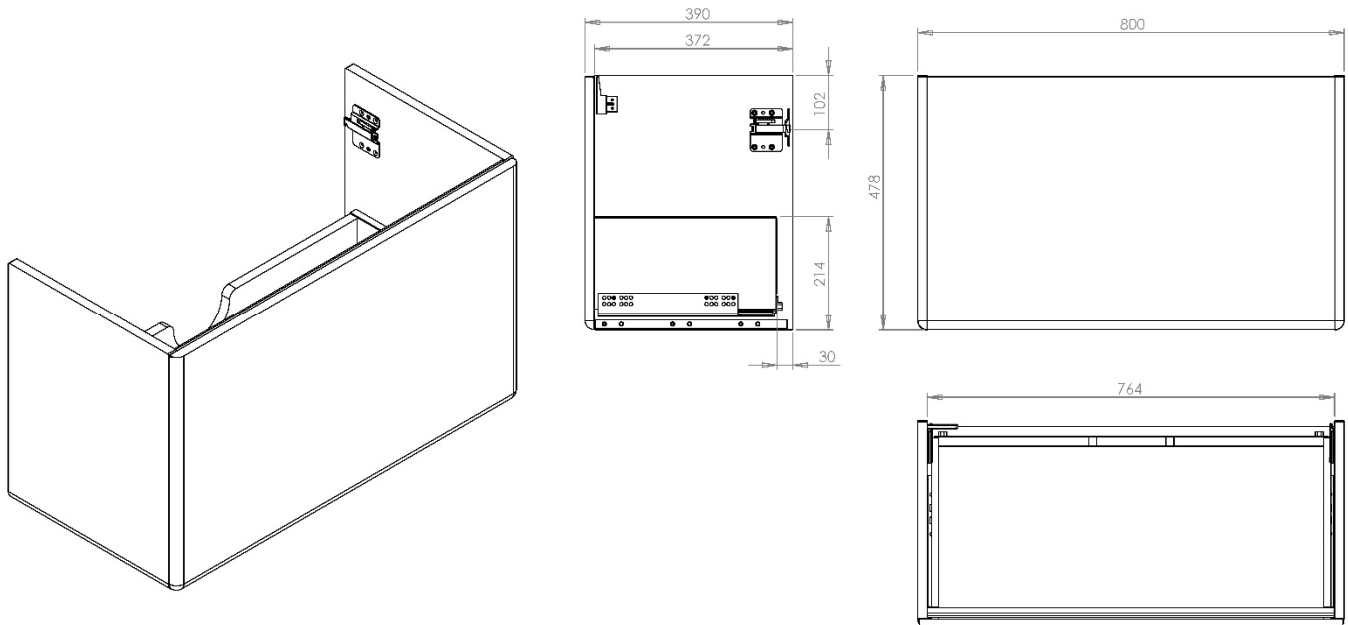

All dimension in mm. Please check dimensions prior to installation as they can vary due to manufacturing tolerances.

**Product Details**

Type:	Single Drawer Washbasin Unit
Width:	800
Depth:	390
Height:	478
Product Weight*:	24.60 kg
Tolerances:	+/- 2mm
Guarantee Period:	5 Years (For Domestic Use) 1 Years (For Commercial Use)
Drawer Box Capacity:	30kg

**Product Specification**

Fascia Material:	18mm MDF
Carcass Material:	18mm MDF/16mm MFC
Available accessories:	Please refer to the Pricelist for further details
Opening Mechanism:	Pull Handle
Adjustable Legs:	N/A
Quantity of Shelves:	N/A
Shelving Type:	N/A
Handing:	N/A

\*Product Weight includes packaging.

**Features**

- FSC Certified
- Soft Close
- Assembled

**Additional Documentation**

Additional Documentation available on our website [www.utopiagroup.com](http://www.utopiagroup.com)

Every effort has been made to ensure that the information provided on this document is correct at the time of creation. Finally, Utopia Furniture Ltd reserve the right to alter materials and specifications in line with continuing programme of production and service development.

**CHIC | 800 WM SINGLE DRAWER WBU FOR SLABTOP BASIN – P2Open\***

CHC008/\*\*\*

\*Push to Open

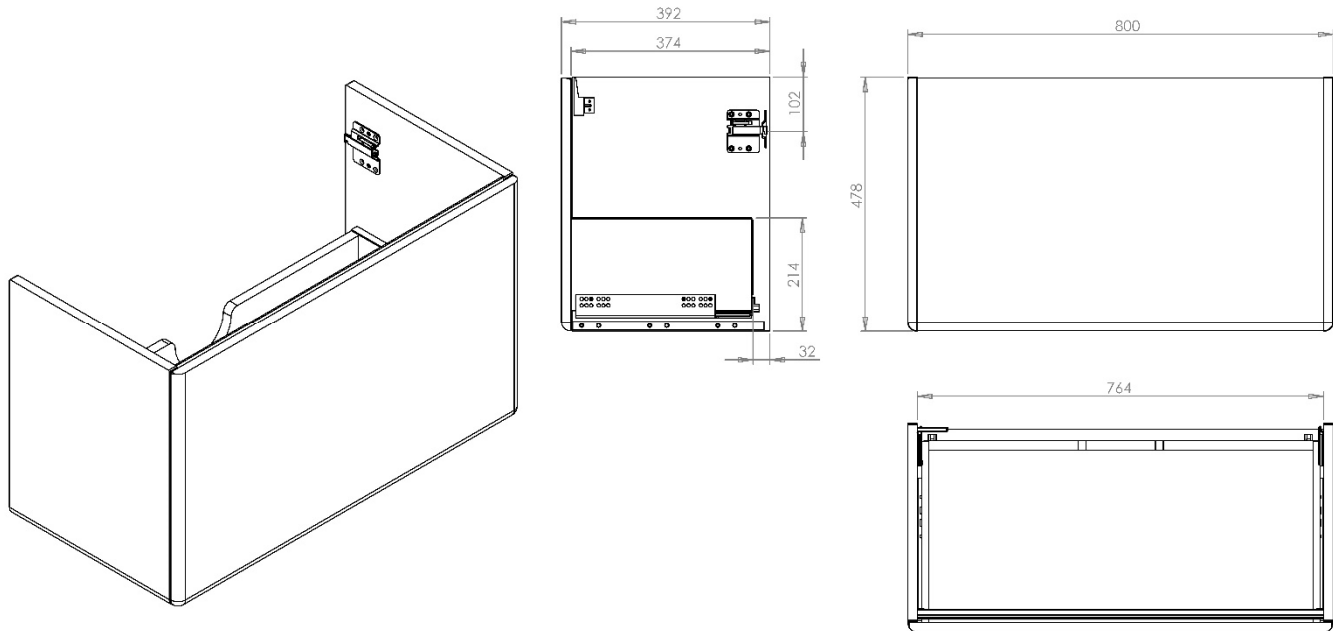

All dimension in mm. Please check dimensions prior to installation as they can vary due to manufacturing tolerances.

**Product Details**

Type:	Single Drawer Washbasin Unit
Width:	800
Depth:	392
Height:	478
Product Weight*:	24.60kg
Tolerances:	+/- 2mm
Guarantee Period:	5 Years (For Domestic Use) 1 Years (For Commercial Use)
Drawer Box Capacity:	30kg

**Product Specification**

Fascia Material:	18mm MDF
Carcass Material:	18mm MDF/16mm MFC
Available accessories:	Please refer to the Pricelist for further details
Opening Mechanism:	Push to Open
Adjustable Legs:	N/A
Quantity of Shelves:	N/A
Shelving Type:	N/A
Handing:	N/A

\*Product Weight includes packaging.

**Features**

- FSC Certified
- Soft Close
- Assembled
- Handleless
- Push to Open

**Additional Documentation**

Additional Documentation available on our website [www.utopiagroup.com](http://www.utopiagroup.com)

Every effort has been made to ensure that the information provided on this document is correct at the time of creation. Finally, Utopia Furniture Ltd reserve the right to alter materials and specifications in line with continuing programme of production and service development.

**CHIC | 600 WM SINGLE DRAWER WBU FOR SIT ON BASIN - PULL**

CHC009/\*\*\*

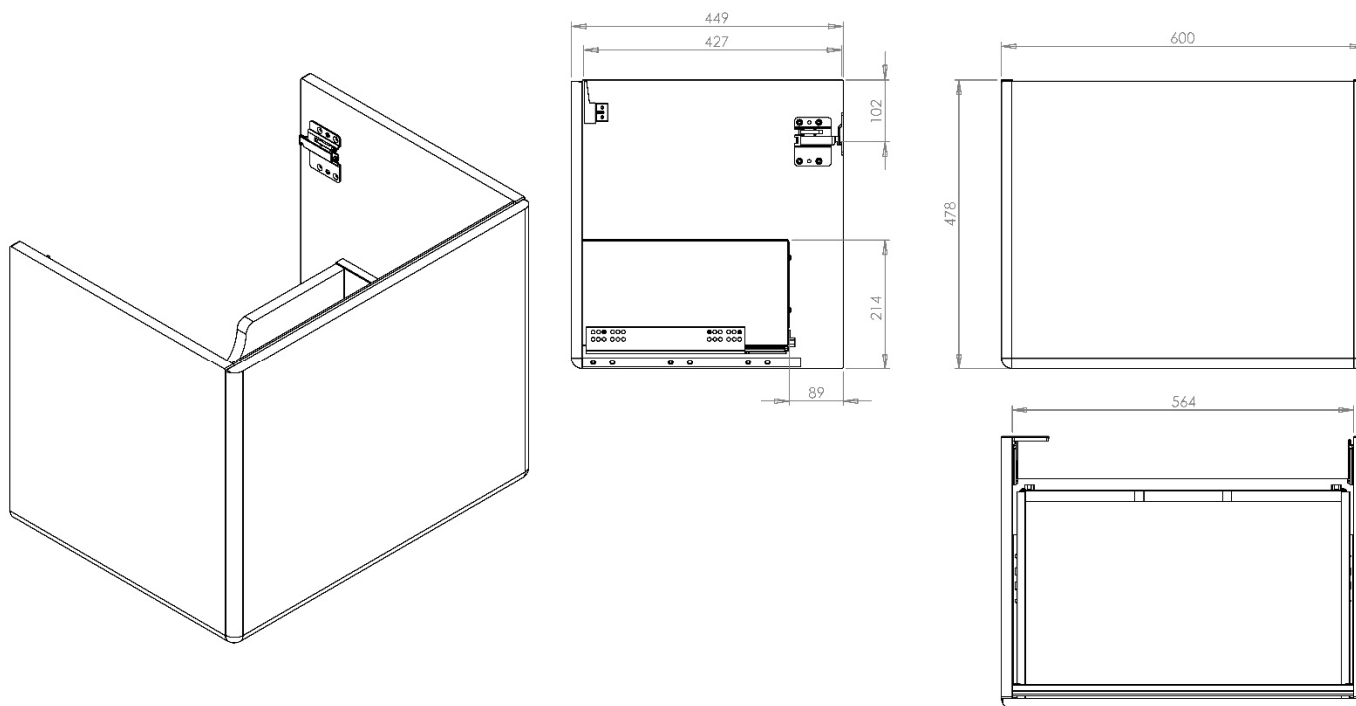

All dimension in mm. Please check dimensions prior to installation as they can vary due to manufacturing tolerances.

**Product Details**

**Product Specification**

Type:	Single Drawer Washbasin Unit
Width:	600
Depth:	449
Height:	478
Product Weight*:	21.80kg
Tolerances:	+/- 2mm
Guarantee Period:	5 Years (For Domestic Use) 1 Years (For Commercial Use)
Drawer Box Capacity:	30kg

Fascia Material:	18mm MDF
Carcass Material:	18mm MDF/16mm MFC
Available accessories:	Please refer to the Pricelist for further details
Opening Mechanism:	Pull Handle
Adjustable Legs:	N/A
Quantity of Shelves:	N/A
Shelving Type:	N/A
Handing:	N/A

\*Product Weight includes packaging.

**Features**

- FSC Certified
- Soft Close
- Assembled

**Additional Documentation**

Additional Documentation available on our website [www.utopiagroup.com](http://www.utopiagroup.com)

Every effort has been made to ensure that the information provided on this document is correct at the time of creation. Finally, Utopia Furniture Ltd reserve the right to alter materials and specifications in line with continuing programme of production and service development.

**CHIC | 600 WM SINGLE DRAWER WBU FOR SIT ON BASIN – P2Open\***

CHC010/\*\*\*

\*Push to Open

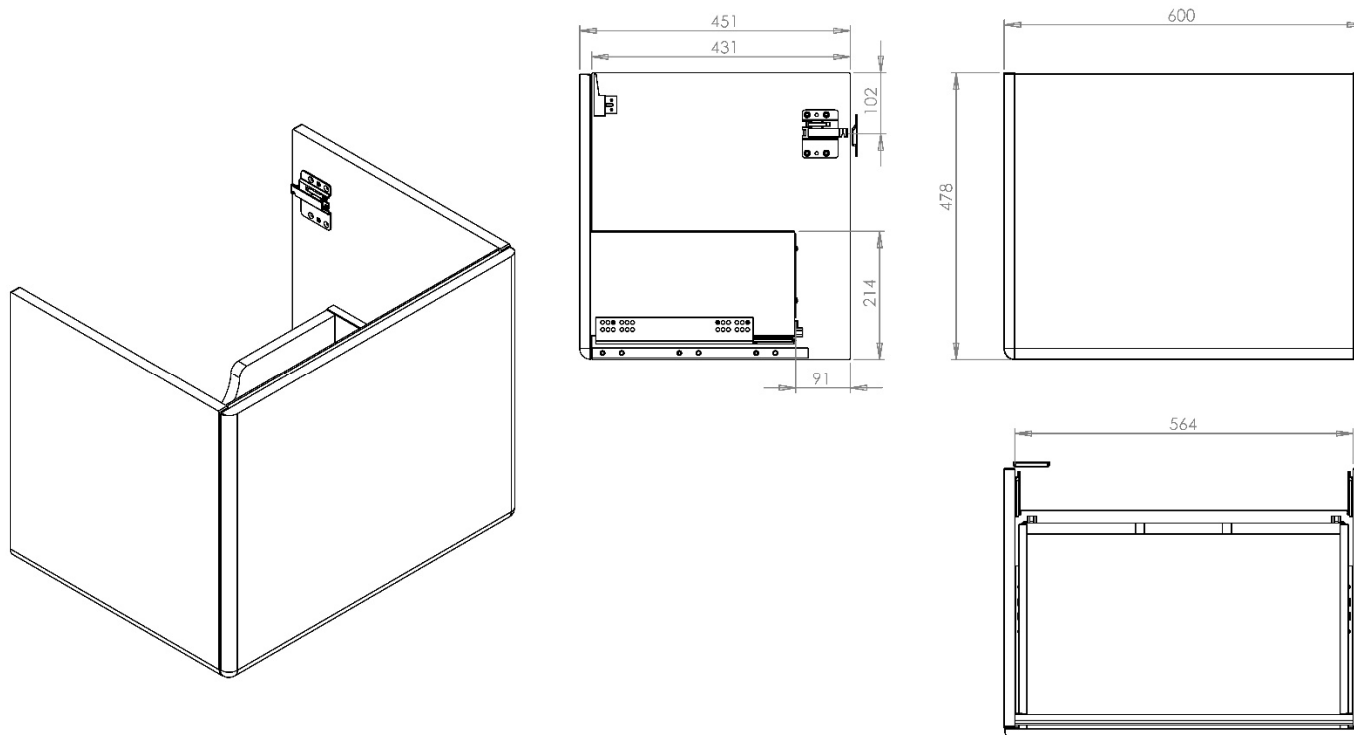

All dimension in mm. Please check dimensions prior to installation as they can vary due to manufacturing tolerances.

**Product Details**

Type:	Single Drawer Washbasin Unit
Width:	600
Depth:	451
Height:	478
Product Weight*:	20.30kg
Tolerances:	+/- 2mm
Guarantee Period:	5 Years (For Domestic Use) 1 Years (For Commercial Use)
Drawer Box Capacity:	30kg

**Product Specification**

Fascia Material:	18mm MDF
Carcass Material:	18mm MDF/16mm MFC
Available accessories:	Please refer to the Pricelist for further details
Opening Mechanism:	Push to Open
Adjustable Legs:	N/A
Quantity of Shelves:	N/A
Shelving Type:	N/A
Handing:	N/A

\*Product Weight includes packaging.

**Features**

- FSC Certified
- Soft Close
- Assembled
- Handleless
- Push to Open

**Additional Documentation**

Additional Documentation available on our website [www.utopiagroup.com](http://www.utopiagroup.com)

Every effort has been made to ensure that the information provided on this document is correct at the time of creation. Finally, Utopia Furniture Ltd reserve the right to alter materials and specifications in line with continuing programme of production and service development.



**CHIC | 800 WM SINGLE DRAWER WBU FOR SIT ON BASIN - PULL**

**CHC011/\*\*\***

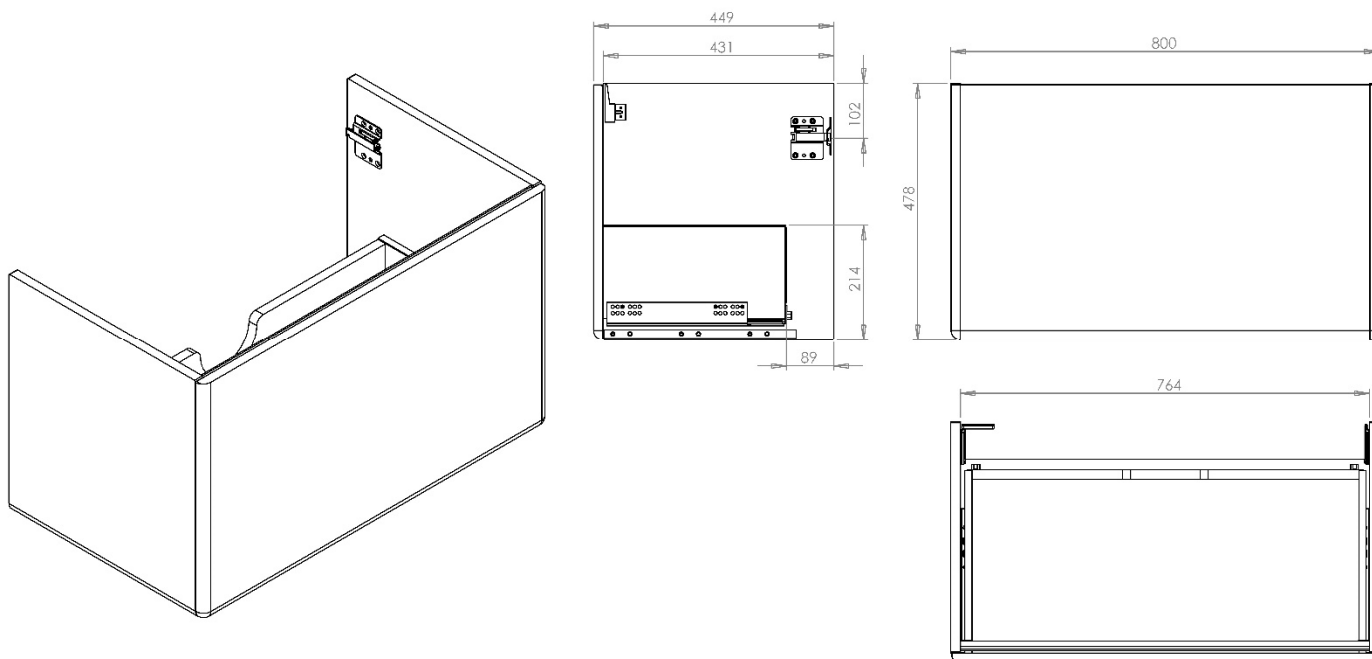

All dimension in mm. Please check dimensions prior to installation as they can vary due to manufacturing tolerances.

**Product Details**

Type:	Single Drawer Washbasin Unit
Width:	800
Depth:	449
Height:	478
Product Weight*:	25.60kg
Tolerances:	+/- 2mm
Guarantee Period:	5 Years (For Domestic Use) 1 Years (For Commercial Use)
Drawer Box Capacity:	30kg

**Product Specification**

Fascia Material:	18mm MDF
Carcass Material:	18mm MDF/16mm MFC
Available accessories:	Please refer to the Pricelist for further details
Opening Mechanism:	Pull Handle
Adjustable Legs:	N/A
Quantity of Shelves:	N/A
Shelving Type:	N/A
Handing:	N/A

\*Product Weight includes packaging.

**Features**

- FSC Certified
- Soft Close
- Assembled

**Additional Documentation**

Additional Documentation available on our website [www.utopiagroup.com](http://www.utopiagroup.com)

Every effort has been made to ensure that the information provided on this document is correct at the time of creation. Finally, Utopia Furniture Ltd reserve the right to alter materials and specifications in line with continuing programme of production and service development.



**CHIC | 800 WM SINGLE DRAWER WBU FOR SIT ON BASIN – P2Open\***

CHC012/\*\*\*

\*Push to Open

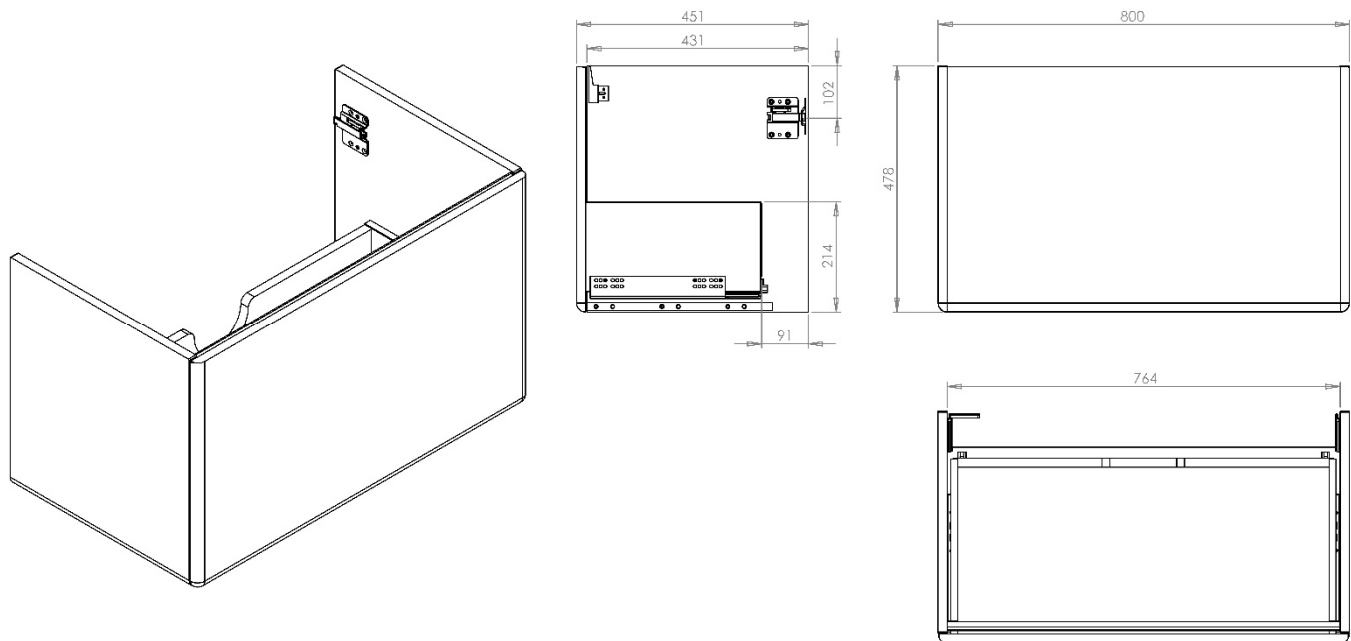

All dimension in mm. Please check dimensions prior to installation as they can vary due to manufacturing tolerances.

**Product Details**

**Product Specification**

Type:	Single Drawer Washbasin Unit
Width:	800
Depth:	451
Height:	478
Product Weight*:	20.30kg
Tolerances:	+/- 2mm
Guarantee Period:	5 Years (For Domestic Use) 1 Years (For Commercial Use)
Drawer Box Capacity:	30kg

Fascia Material:	18mm MDF
Carcass Material:	18mm MDF/16mm MFC
Available accessories:	Please refer to the Pricelist for further details
Opening Mechanism:	Push to Open
Adjustable Legs:	N/A
Quantity of Shelves:	N/A
Shelving Type:	N/A
Handing:	N/A

\*Product Weight includes packaging.

**Features**

- FSC Certified
- Soft Close
- Assembled
- Handleless
- Push to Open

**Additional Documentation**

Additional Documentation available on our website [www.utopiagroup.com](http://www.utopiagroup.com)

Every effort has been made to ensure that the information provided on this document is correct at the time of creation. Finally, Utopia Furniture Ltd reserve the right to alter materials and specifications in line with continuing programme of production and service development.

**CHIC | 600 WM DBL DRAWER WBU FOR SLABTOP BASIN - PULL**

**CHC013/\*\*\***

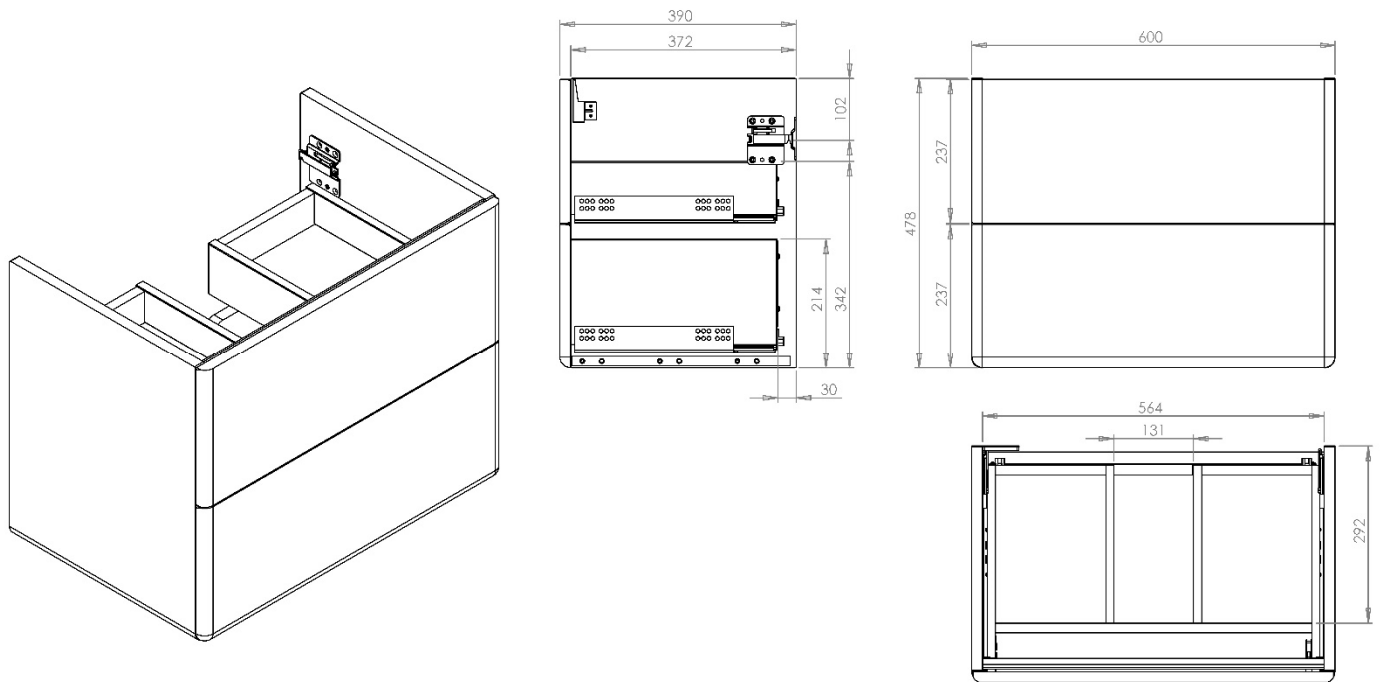

All dimension in mm. Please check dimensions prior to installation as they can vary due to manufacturing tolerances.

**Product Details**

Type:	Double Drawer Washbasin Unit
Width:	600
Depth:	390
Height:	478
Product Weight*:	26.30kg
Tolerances:	+/- 2mm
Guarantee Period:	5 Years (For Domestic Use) 1 Years (For Commercial Use)
Drawer Box Capacity:	30kg

**Product Specification**

Fascia Material:	18mm MDF
Carcass Material:	18mm MDF/16mm MFC
Available accessories:	Please refer to the Pricelist for further details
Opening Mechanism:	Pull Handle
Adjustable Legs:	N/A
Quantity of Shelves:	N/A
Shelving Type:	N/A
Handing:	N/A

\*Product Weight includes packaging.

**Features**

- FSC Certified
- Soft Close
- Assembled

**Additional Documentation**

Additional Documentation available on our website [www.utopiagroup.com](http://www.utopiagroup.com)

Every effort has been made to ensure that the information provided on this document is correct at the time of creation. Finally, Utopia Furniture Ltd reserve the right to alter materials and specifications in line with continuing programme of production and service development.

**CHIC | 600 WM DOUBLE DRAWER WBU FOR SLABTOP BASIN – P2Open\***

CHC014/\*\*\*

\*Push to Open

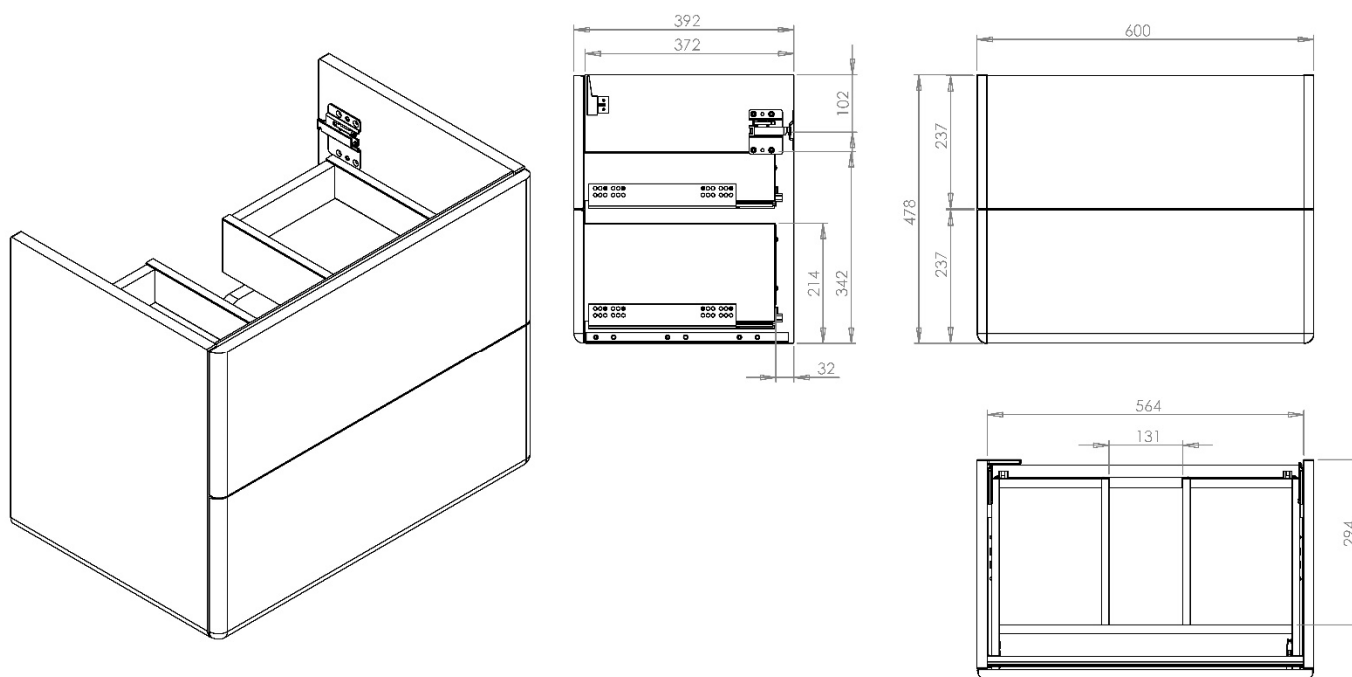

All dimension in mm. Please check dimensions prior to installation as they can vary due to manufacturing tolerances.

**Product Details**

Type:	Double Drawer Washbasin Unit
Width:	600
Depth:	392
Height:	478
Product Weight*:	20.30kg
Tolerances:	+/- 2mm
Guarantee Period:	5 Years (For Domestic Use) 1 Years (For Commercial Use)
Drawer Box Capacity:	30kg

**Product Specification**

Fascia Material:	18mm MDF
Carcass Material:	18mm MDF/16mm MFC
Available accessories:	Please refer to the Pricelist for further details
Opening Mechanism:	Push to Open
Adjustable Legs:	N/A
Quantity of Shelves:	N/A
Shelving Type:	N/A
Handing:	N/A

\*Product Weight includes packaging.

**Features**

- FSC Certified
- Soft Close
- Assembled
- Handleless
- Push to Open

**Additional Documentation**

Additional Documentation available on our website [www.utopiagroup.com](http://www.utopiagroup.com)

Every effort has been made to ensure that the information provided on this document is correct at the time of creation. Finally, Utopia Furniture Ltd reserve the right to alter materials and specifications in line with continuing programme of production and service development.

**CHIC | 800 WM DBL DRAWER WBU FOR SLABTOP BASIN - PULL**

CHC015/\*\*\*

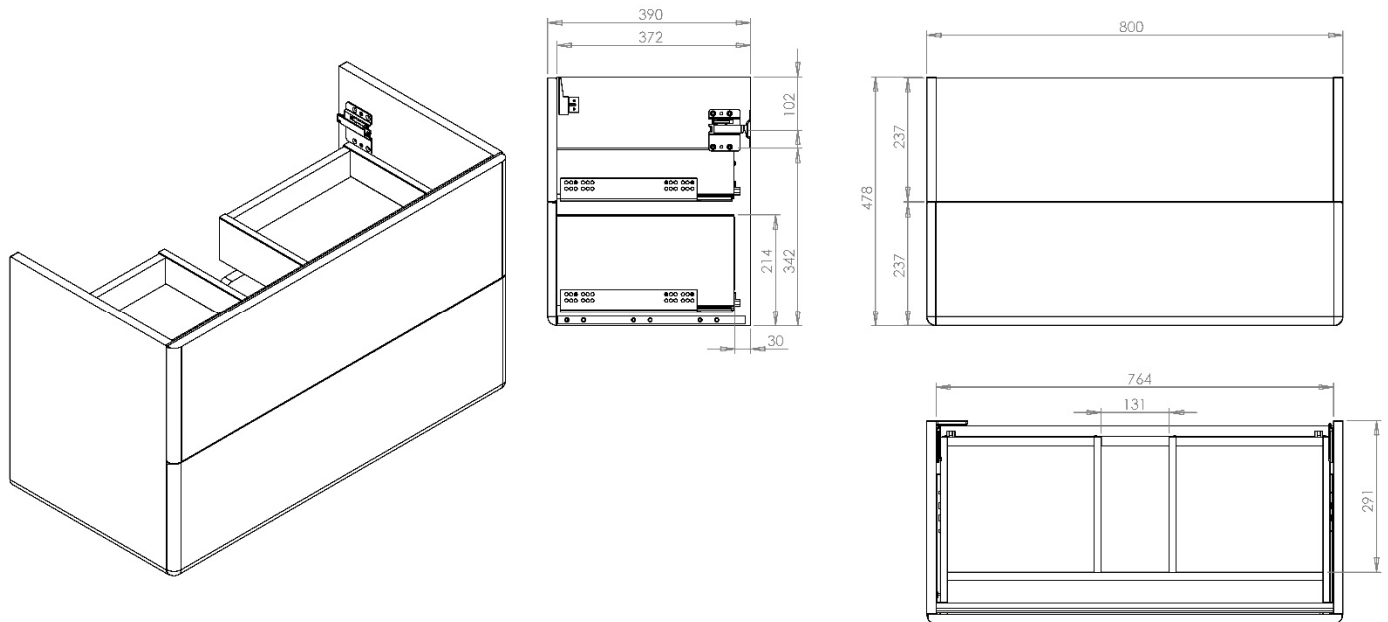

All dimension in mm. Please check dimensions prior to installation as they can vary due to manufacturing tolerances.

**Product Details**

Type:	Double Drawer Washbasin Unit
Width:	800
Depth:	390
Height:	478
Product Weight*:	31.10kg
Tolerances:	+/- 2mm
Guarantee Period:	5 Years (For Domestic Use) 1 Years (For Commercial Use)
Drawer Box Capacity:	30kg

**Product Specification**

Fascia Material:	18mm MDF
Carcass Material:	18mm MDF/16mm MFC
Available accessories:	Please refer to the Pricelist for further details
Opening Mechanism:	Pull Handle
Adjustable Legs:	N/A
Quantity of Shelves:	N/A
Shelving Type:	N/A
Handing:	N/A

\*Product Weight includes packaging.

**Features**

- FSC Certified
- Soft Close
- Assembled

**Additional Documentation**

Additional Documentation available on our website [www.utopiagroup.com](http://www.utopiagroup.com)

Every effort has been made to ensure that the information provided on this document is correct at the time of creation. Finally, Utopia Furniture Ltd reserve the right to alter materials and specifications in line with continuing programme of production and service development.

**CHIC | 800 WM DBL DRAWER WBU FOR SLABTOP BASIN – P2Open\***

CHC016/\*\*\*

\*Push to Open

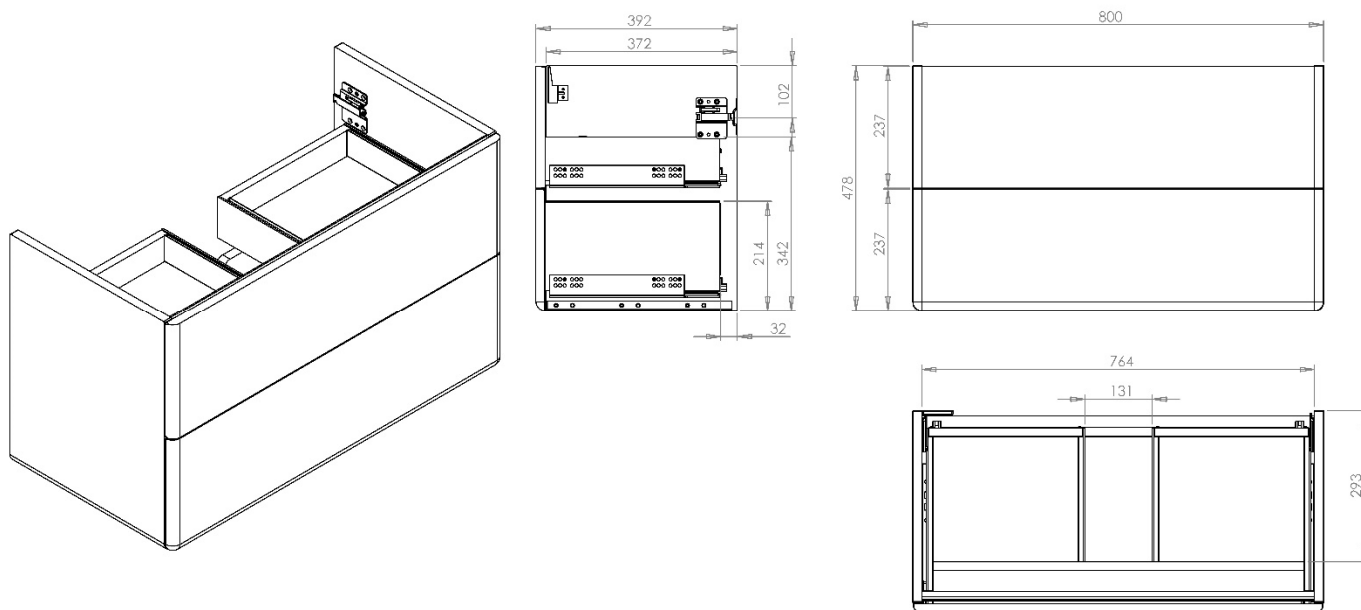

All dimension in mm. Please check dimensions prior to installation as they can vary due to manufacturing tolerances.

**Product Details**

Type:	Double Drawer Washbasin Unit
Width:	800
Depth:	392
Height:	478
Product Weight*:	20.30kg
Tolerances:	+/- 2mm
Guarantee Period:	5 Years (For Domestic Use) 1 Years (For Commercial Use)
Drawer Box Capacity:	30kg

**Product Specification**

Fascia Material:	18mm MDF
Carcass Material:	18mm MDF/16mm MFC
Available accessories:	Please refer to the Pricelist for further details
Opening Mechanism:	Push to Open
Adjustable Legs:	N/A
Quantity of Shelves:	N/A
Shelving Type:	N/A
Handing:	N/A

\*Product Weight includes packaging.

**Features**

- FSC Certified
- Soft Close
- Assembled
- Handleless
- Push to Open

**Additional Documentation**

Additional Documentation available on our website [www.utopiagroup.com](http://www.utopiagroup.com)

Every effort has been made to ensure that the information provided on this document is correct at the time of creation. Finally, Utopia Furniture Ltd reserve the right to alter materials and specifications in line with continuing programme of production and service development.

**CHIC | 600 WM DBL DRAWER WBU FOR SIT ON BASIN - PULL**

CHC017/\*\*\*

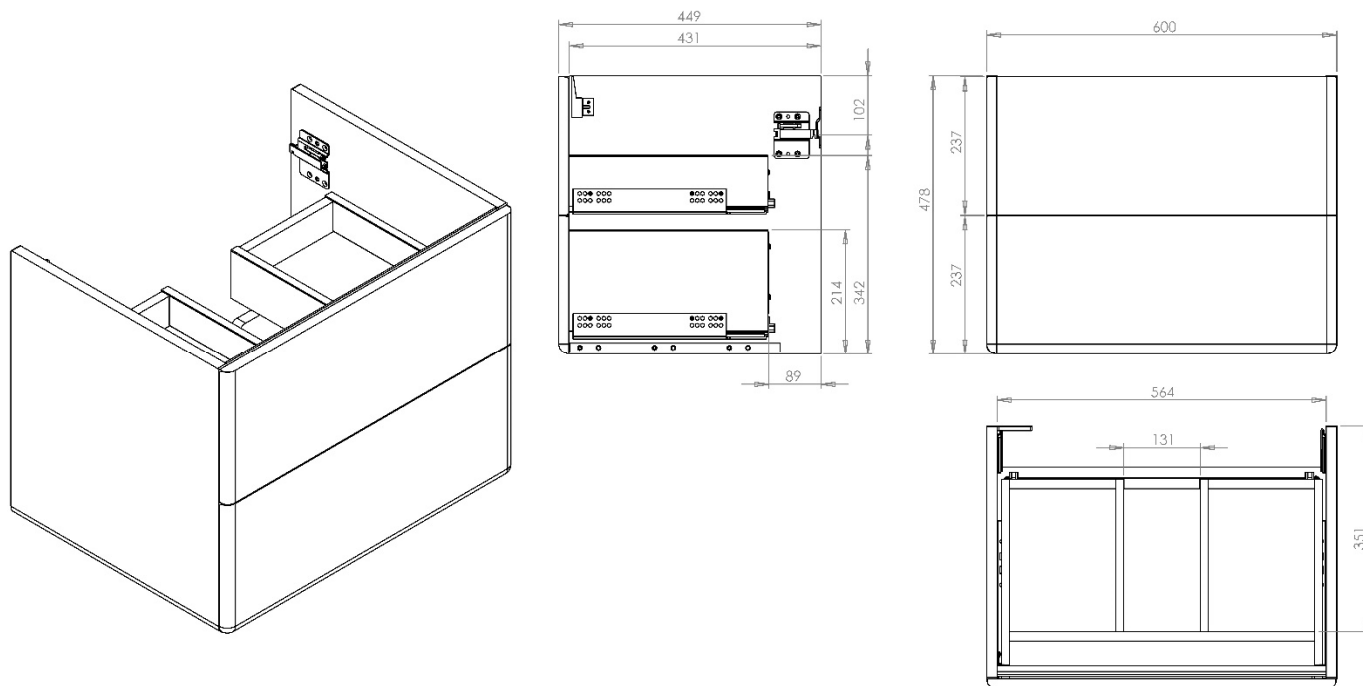

All dimension in mm. Please check dimensions prior to installation as they can vary due to manufacturing tolerances.

**Product Details**

Type:	Double Drawer Washbasin Unit
Width:	600
Depth:	449
Height:	478
Product Weight*:	27.30kg
Tolerances:	+/- 2mm
Guarantee Period:	5 Years (For Domestic Use) 1 Years (For Commercial Use)
Drawer Box Capacity:	30kg

**Product Specification**

Fascia Material:	18mm MDF
Carcass Material:	18mm MDF/16mm MFC
Available accessories:	Please refer to the Pricelist for further details
Opening Mechanism:	Pull Handle
Adjustable Legs:	N/A
Quantity of Shelves:	N/A
Shelving Type:	N/A
Handing:	N/A

\*Product Weight includes packaging.

**Features**

- FSC Certified
- Soft Close
- Assembled

**Additional Documentation**

Additional Documentation available on our website [www.utopiagroup.com](http://www.utopiagroup.com)

Every effort has been made to ensure that the information provided on this document is correct at the time of creation. Finally, Utopia Furniture Ltd reserve the right to alter materials and specifications in line with continuing programme of production and service development.

**CHIC | 600 WM DBL DRAWER WBU FOR SIT ON BASIN – P2Open\***

CHC018/\*\*\*

\*Push to Open

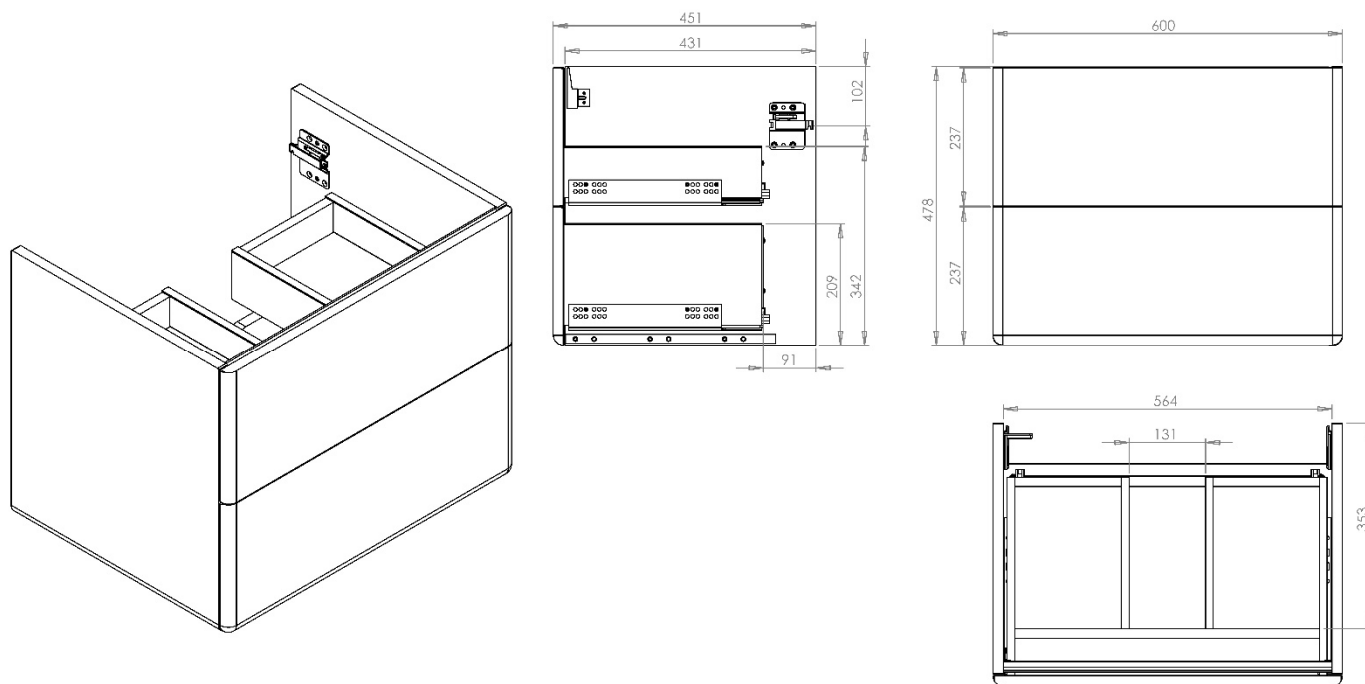

All dimension in mm. Please check dimensions prior to installation as they can vary due to manufacturing tolerances.

**Product Details**

**Product Specification**

Type:	Double Drawer Washbasin Unit
Width:	600
Depth:	451
Height:	478
Product Weight*:	20.30kg
Tolerances:	+/- 2mm
Guarantee Period:	5 Years (For Domestic Use) 1 Years (For Commercial Use)
Drawer Box Capacity:	30kg

Fascia Material:	18mm MDF
Carcass Material:	18mm MDF/16mm MFC
Available accessories:	Please refer to the Pricelist for further details
Opening Mechanism:	Push to Open
Adjustable Legs:	N/A
Quantity of Shelves:	N/A
Shelving Type:	N/A
Handing:	N/A

\*Product Weight includes packaging.

**Features**

- FSC Certified
- Soft Close
- Assembled
- Handleless
- Push to Open

**Additional Documentation**

Additional Documentation available on our website [www.utopiagroup.com](http://www.utopiagroup.com)

Every effort has been made to ensure that the information provided on this document is correct at the time of creation. Finally, Utopia Furniture Ltd reserve the right to alter materials and specifications in line with continuing programme of production and service development.



**CHIC | 800 WM DBL DRAWER WBU FOR SIT ON BASIN - PULL**

**CHC019/\*\*\***

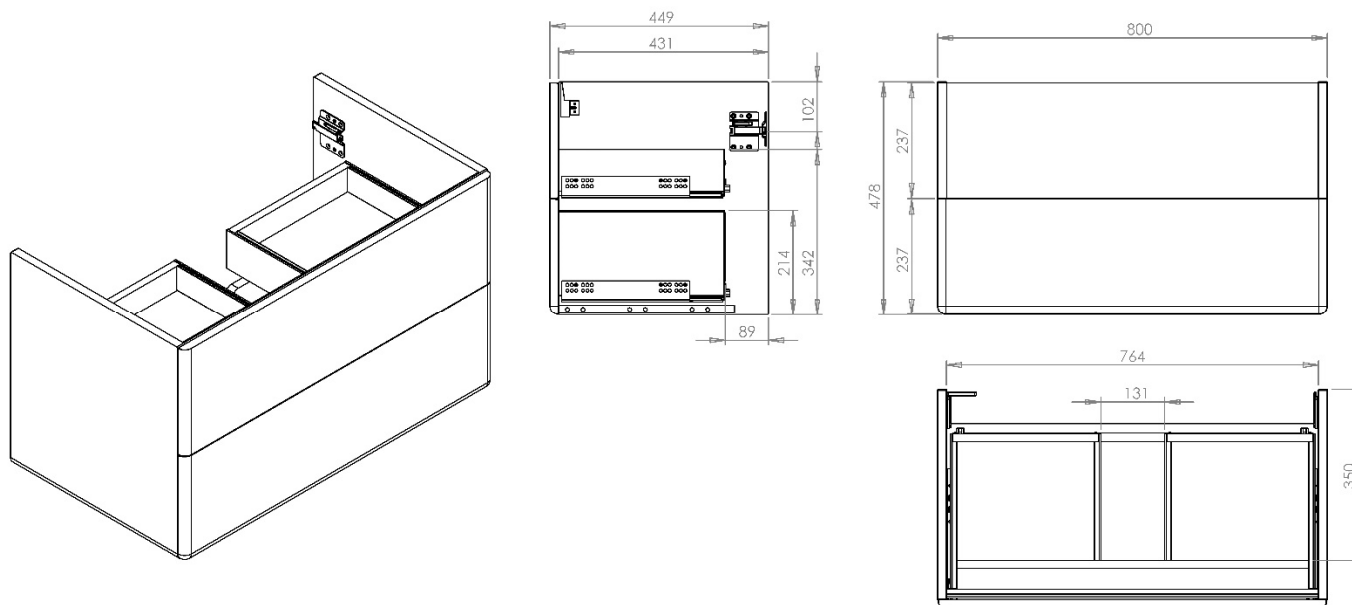

All dimension in mm. Please check dimensions prior to installation as they can vary due to manufacturing tolerances.

**Product Details**

Type:	Double Drawer Washbasin Unit
Width:	800
Depth:	449
Height:	478
Product Weight*:	32.00kg
Tolerances:	+/- 2mm
Guarantee Period:	5 Years (For Domestic Use) 1 Years (For Commercial Use)
Drawer Box Capacity:	30kg

**Product Specification**

Fascia Material:	18mm MDF
Carcass Material:	18mm MDF/16mm MFC
Available accessories:	Please refer to the Pricelist for further details
Opening Mechanism:	Pull Handle
Adjustable Legs:	N/A
Quantity of Shelves:	N/A
Shelving Type:	N/A
Handing:	N/A

\*Product Weight includes packaging.

**Features**

- FSC Certified
- Soft Close
- Assembled

**Additional Documentation**

Additional Documentation available on our website [www.utopiagroup.com](http://www.utopiagroup.com)

Every effort has been made to ensure that the information provided on this document is correct at the time of creation. Finally, Utopia Furniture Ltd reserve the right to alter materials and specifications in line with continuing programme of production and service development.



**CHIC | 800 WM DBL DRAWER WBU FOR SIT ON BASIN – P2Open\***

CHC020/\*\*\*

\*Push to Open

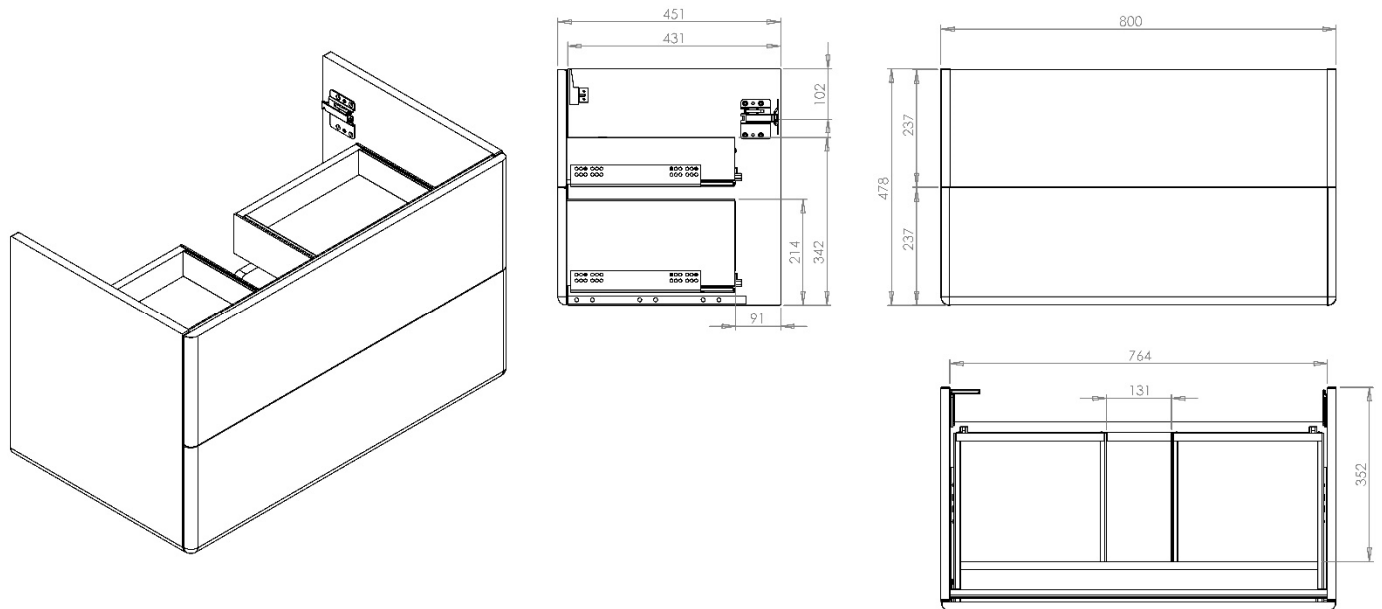

All dimension in mm. Please check dimensions prior to installation as they can vary due to manufacturing tolerances.

**Product Details**

**Product Specification**

Type:	Double Drawer Washbasin Unit
Width:	800
Depth:	451
Height:	478
Product Weight*:	20.30kg
Tolerances:	+/- 2mm
Guarantee Period:	5 Years (For Domestic Use) 1 Years (For Commercial Use)
Drawer Box Capacity:	30kg

Fascia Material:	18mm MDF
Carcass Material:	18mm MDF/16mm MFC
Available accessories:	Please refer to the Pricelist for further details
Opening Mechanism:	Push to Open
Adjustable Legs:	N/A
Quantity of Shelves:	N/A
Shelving Type:	N/A
Handing:	N/A

\*Product Weight includes packaging.

**Features**

- FSC Certified
- Soft Close
- Assembled
- Handleless
- Push to Open

**Additional Documentation**

Additional Documentation available on our website [www.utopiagroup.com](http://www.utopiagroup.com)

Every effort has been made to ensure that the information provided on this document is correct at the time of creation. Finally, Utopia Furniture Ltd reserve the right to alter materials and specifications in line with continuing programme of production and service development.

**CHIC | 1200 WM TWIN SINGLE DRAWER WBU FOR SIT ON BASIN - PULL**

CHC021/\*\*\*

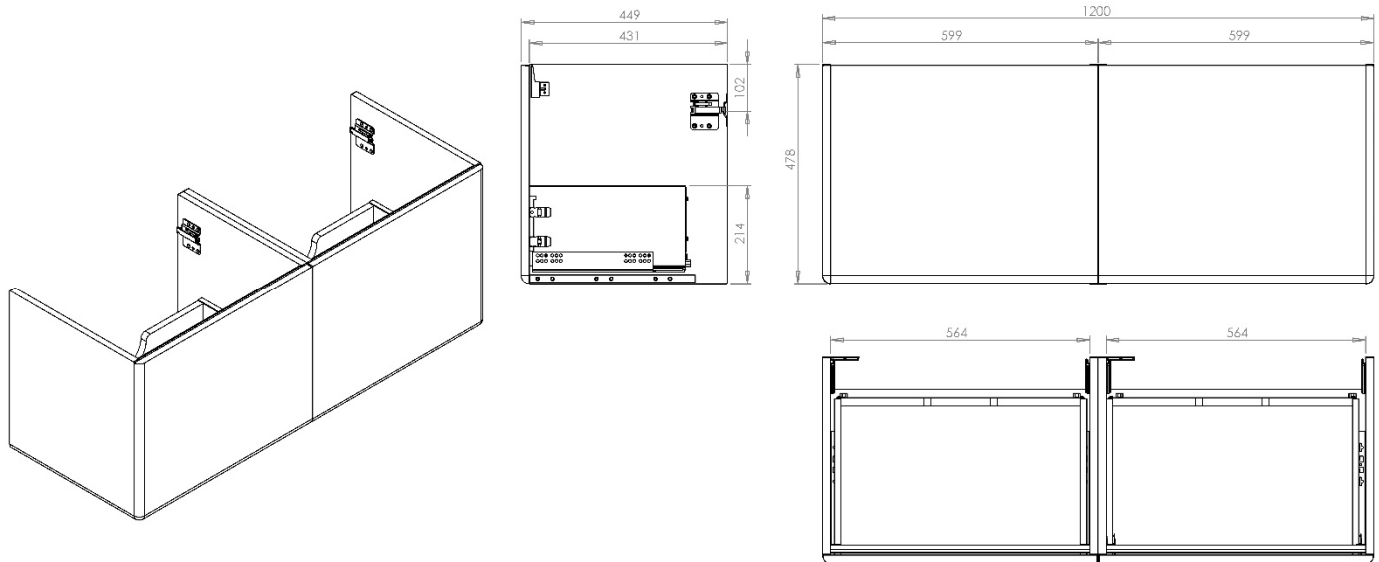

All dimension in mm. Please check dimensions prior to installation as they can vary due to manufacturing tolerances.

**Product Details**

Type:	Twin Single Drawer Washbasin Unit
Width:	1200
Depth:	449
Height:	478
Product Weight*:	43.3kg
Tolerances:	+/- 2mm
Guarantee Period:	5 Years (For Domestic Use) 1 Years (For Commercial Use)
Drawer Box Capacity:	30kg

**Product Specification**

Fascia Material:	18mm MDF
Carcass Material:	18mm MDF/16mm MFC
Available accessories:	Please refer to the Pricelist for further details
Opening Mechanism:	Pull Handle
Adjustable Legs:	N/A
Quantity of Shelves:	N/A
Shelving Type:	N/A
Handing:	N/A

\*Product Weight includes packaging.

**Features**

- FSC Certified
- Soft Close
- Assembled

**Additional Documentation**

Additional Documentation available on our website [www.utopiagroup.com](http://www.utopiagroup.com)

Every effort has been made to ensure that the information provided on this document is correct at the time of creation. Finally, Utopia Furniture Ltd reserve the right to alter materials and specifications in line with continuing programme of production and service development.

**CHIC | 1200 WM TWIN SINGLE DRAWER WBU FOR SIT ON BASIN – P2Open\***

CHC022/\*\*\*

\*Push to Open

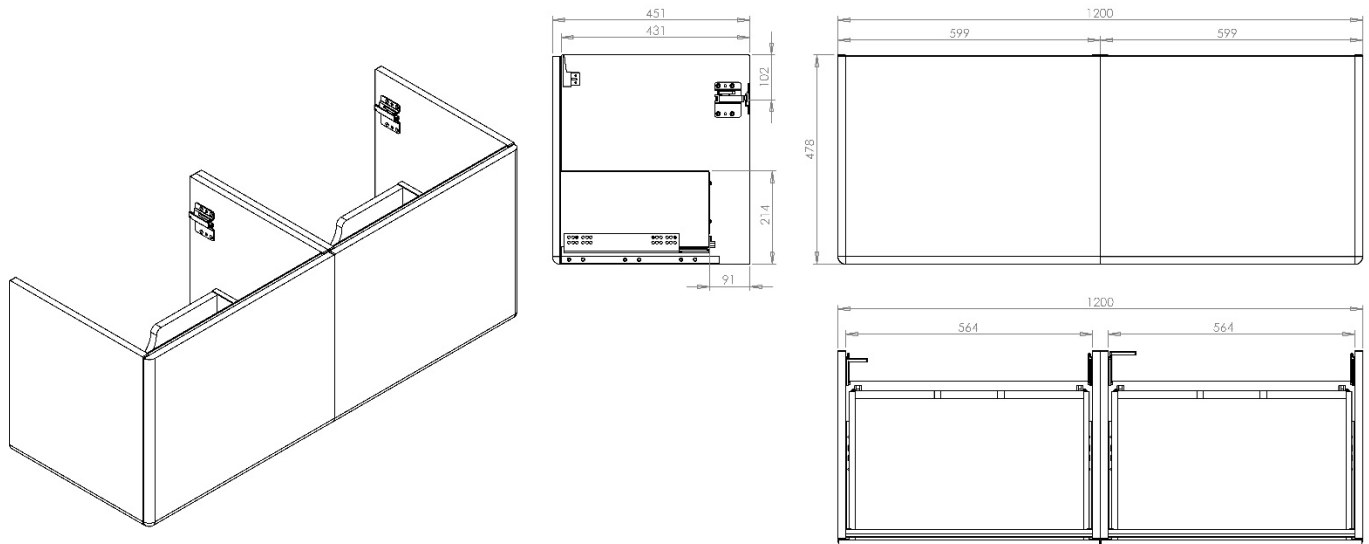

All dimension in mm. Please check dimensions prior to installation as they can vary due to manufacturing tolerances.

**Product Details**

Type:	Twin Single Drawer Washbasin Unit
Width:	1200
Depth:	451
Height:	478
Product Weight*:	43.6kg
Tolerances:	+/- 2mm
Guarantee Period:	5 Years (For Domestic Use) 1 Years (For Commercial Use)
Drawer Box Capacity:	30kg

**Product Specification**

Fascia Material:	18mm MDF
Carcass Material:	18mm MDF/16mm MFC
Available accessories:	Please refer to the Pricelist for further details
Opening Mechanism:	Push to Open
Adjustable Legs:	N/A
Quantity of Shelves:	N/A
Shelving Type:	N/A
Handing:	N/A

\*Product Weight includes packaging.

**Features**

- FSC Certified
- Soft Close
- Assembled
- Handleless
- Push to Open

**Additional Documentation**

Additional Documentation available on our website [www.utopiagroup.com](http://www.utopiagroup.com)

Every effort has been made to ensure that the information provided on this document is correct at the time of creation. Finally, Utopia Furniture Ltd reserve the right to alter materials and specifications in line with continuing programme of production and service development.

**CHIC | 1600 WM TWIN SINGLE DRAWER WBU FOR SIT ON BASIN - PULL**

CHC023/\*\*\*

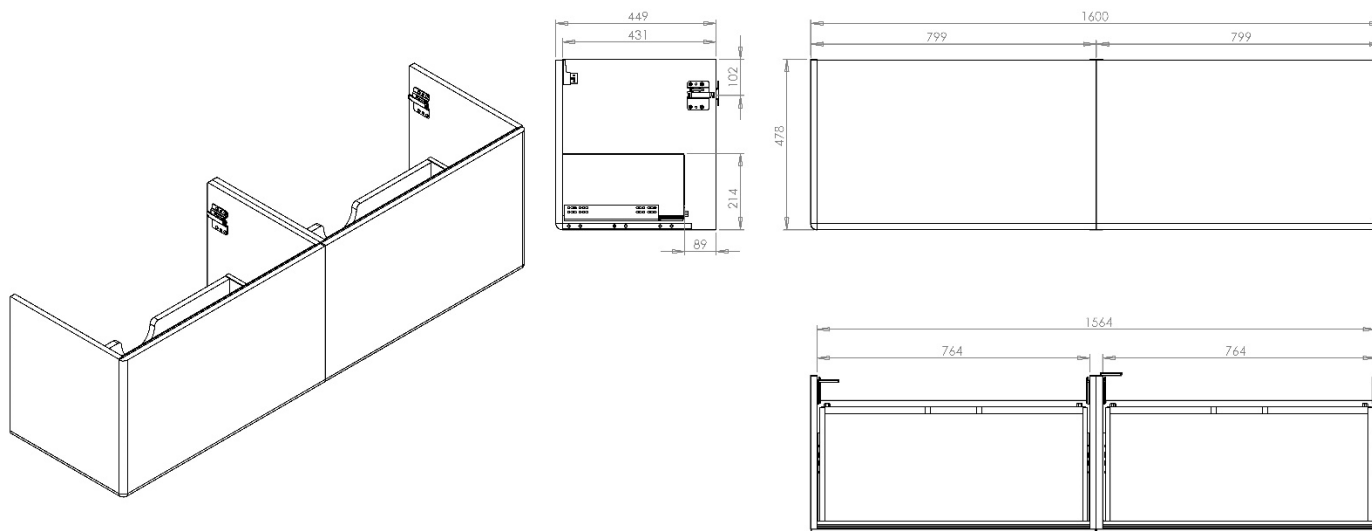

All dimension in mm. Please check dimensions prior to installation as they can vary due to manufacturing tolerances.

**Product Details**

Type:	Twin Single Drawer Washbasin Unit
Width:	1600
Depth:	449
Height:	478
Product Weight*:	50.80kg
Tolerances:	+/- 2mm
Guarantee Period:	5 Years (For Domestic Use) 1 Years (For Commercial Use)
Drawer Box Capacity:	30kg

**Product Specification**

Fascia Material:	18mm MDF
Carcass Material:	18mm MDF/16mm MFC
Available accessories:	Please refer to the Pricelist for further details
Opening Mechanism:	Pull Handle
Adjustable Legs:	N/A
Quantity of Shelves:	N/A
Shelving Type:	N/A
Handing:	N/A

\*Product Weight includes packaging.

**Features**

- FSC Certified
- Soft Close
- Assembled

**Additional Documentation**

Additional Documentation available on our website [www.utopiagroup.com](http://www.utopiagroup.com)

Every effort has been made to ensure that the information provided on this document is correct at the time of creation. Finally, Utopia Furniture Ltd reserve the right to alter materials and specifications in line with continuing programme of production and service development.

**CHIC | 1600 WM TWIN SINGLE DRAWER WBU FOR SIT ON BASIN – P2Open\***

CHC024/\*\*\*

\*Push to Open

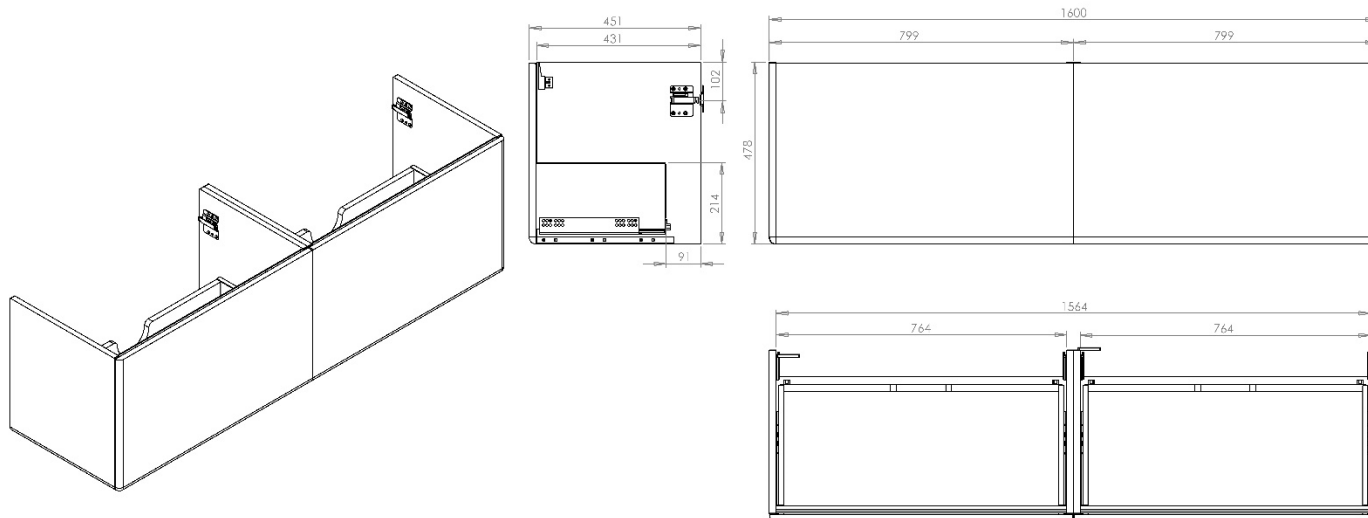

All dimension in mm. Please check dimensions prior to installation as they can vary due to manufacturing tolerances.

**Product Details**

**Product Specification**

Type:	Twin Single Drawer Washbasin Unit
Width:	1600
Depth:	451
Height:	478
Product Weight*:	51.10kg
Tolerances:	+/- 2mm
Guarantee Period:	5 Years (For Domestic Use) 1 Years (For Commercial Use)
Drawer Box Capacity:	30kg

Fascia Material:	18mm MDF
Carcass Material:	18mm MDF/16mm MFC
Available accessories:	Please refer to the Pricelist for further details
Opening Mechanism:	Push to Open
Adjustable Legs:	N/A
Quantity of Shelves:	N/A
Shelving Type:	N/A
Handing:	N/A

\*Product Weight includes packaging.

**Features**

- FSC Certified
- Soft Close
- Assembled
- Handleless
- Push to Open

**Additional Documentation**

Additional Documentation available on our website [www.utopiagroup.com](http://www.utopiagroup.com)

Every effort has been made to ensure that the information provided on this document is correct at the time of creation. Finally, Utopia Furniture Ltd reserve the right to alter materials and specifications in line with continuing programme of production and service development.

**CHIC | 1200 WM DBL DRAWER WBU FOR SIT ON BASIN - PULL**

CHC025/\*\*\*

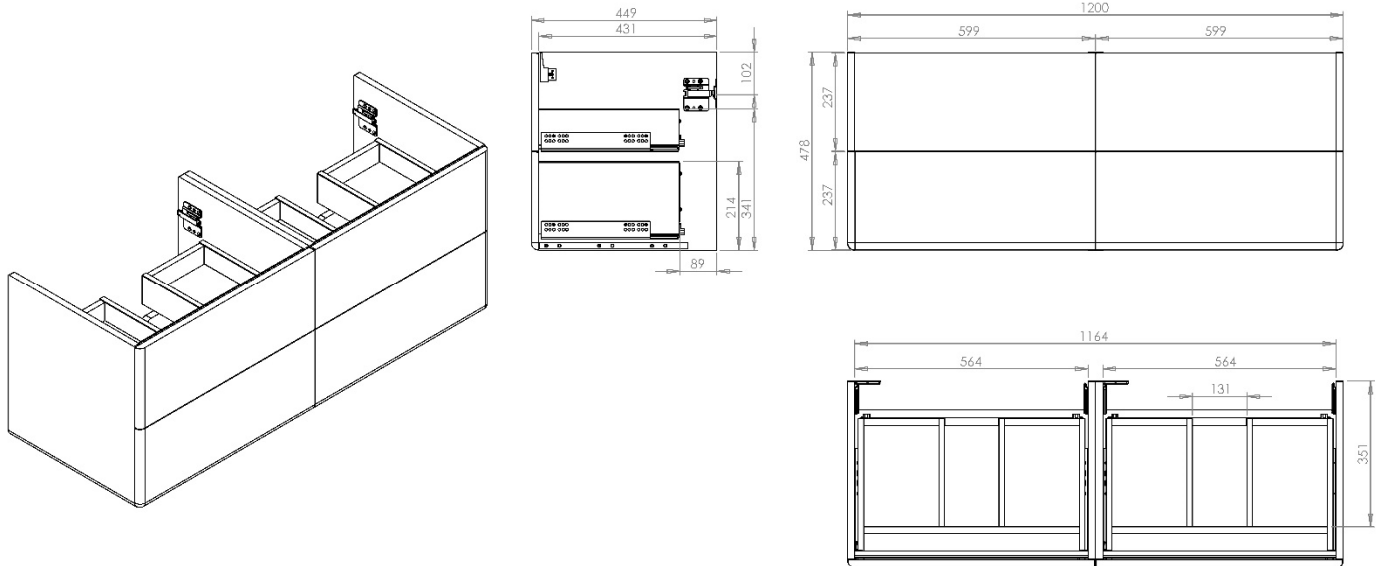

All dimension in mm. Please check dimensions prior to installation as they can vary due to manufacturing tolerances.

**Product Details**

Type:	Twin Double Drawer Washbasin Unit
Width:	1200
Depth:	449
Height:	478
Product Weight*:	54.2kg
Tolerances:	+/- 2mm
Guarantee Period:	5 Years (For Domestic Use) 1 Years (For Commercial Use)
Drawer Box Capacity:	30kg

**Product Specification**

Fascia Material:	18mm MDF
Carcass Material:	18mm MDF/16mm MFC
Available accessories:	Please refer to the Pricelist for further details
Opening Mechanism:	Pull Handle
Adjustable Legs:	N/A
Quantity of Shelves:	N/A
Shelving Type:	N/A
Handing:	N/A

\*Product Weight includes packaging.

**Features**

- FSC Certified
- Soft Close
- Assembled

**Additional Documentation**

Additional Documentation available on our website [www.utopiagroup.com](http://www.utopiagroup.com)

Every effort has been made to ensure that the information provided on this document is correct at the time of creation. Finally, Utopia Furniture Ltd reserve the right to alter materials and specifications in line with continuing programme of production and service development.

**CHIC | 1200 WM TWIN DBL DRAWER WBU FOR SIT ON BASIN – P2Open\***

CHC026/\*\*\*

\*Push to Open

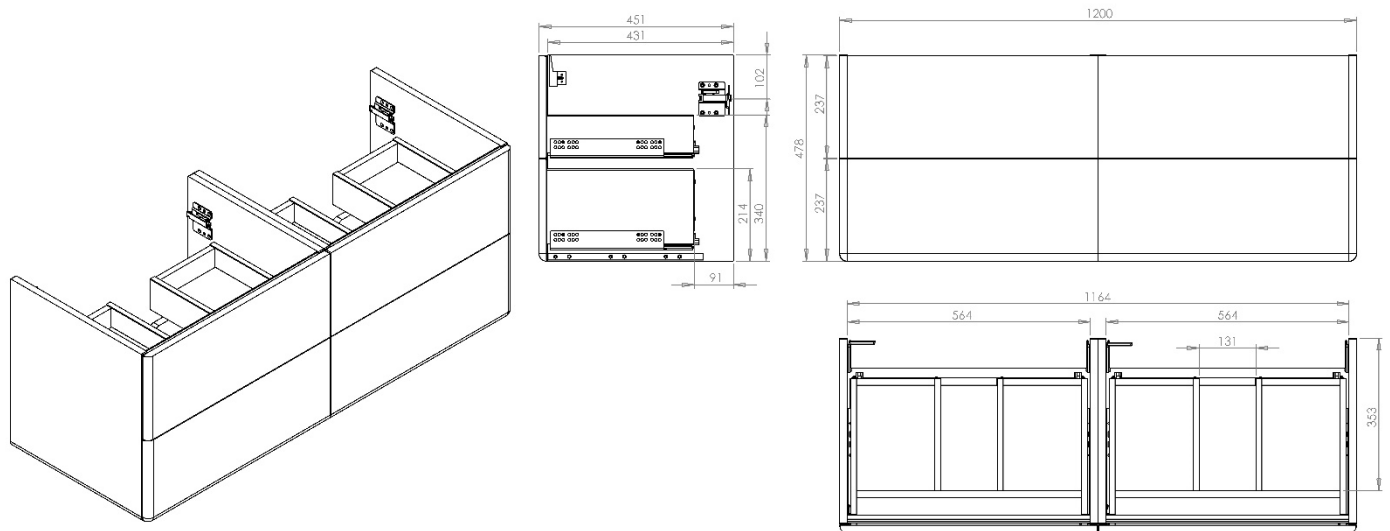

All dimension in mm. Please check dimensions prior to installation as they can vary due to manufacturing tolerances.

**Product Details**

**Product Specification**

Type:	Twin Double Drawer Washbasin Unit
Width:	1200
Depth:	451
Height:	478
Product Weight*:	54.8kg
Tolerances:	+/- 2mm
Guarantee Period:	5 Years (For Domestic Use) 1 Years (For Commercial Use)
Drawer Box Capacity:	30kg

Fascia Material:	18mm MDF
Carcass Material:	18mm MDF/16mm MFC
Available accessories:	Please refer to the Pricelist for further details
Opening Mechanism:	Push to Open
Adjustable Legs:	N/A
Quantity of Shelves:	N/A
Shelving Type:	N/A
Handing:	N/A

\*Product Weight includes packaging.

**Features**

- FSC Certified
- Soft Close
- Assembled
- Handleless
- Push to Open

**Additional Documentation**

Additional Documentation available on our website [www.utopiagroup.com](http://www.utopiagroup.com)

Every effort has been made to ensure that the information provided on this document is correct at the time of creation. Finally, Utopia Furniture Ltd reserve the right to alter materials and specifications in line with continuing programme of production and service development.



**CHIC | 1600 WM TWIN DBL DRAWER WBU FOR SIT ON BASIN – P2Open\***

CHC028/\*\*\*

\*Push to Open

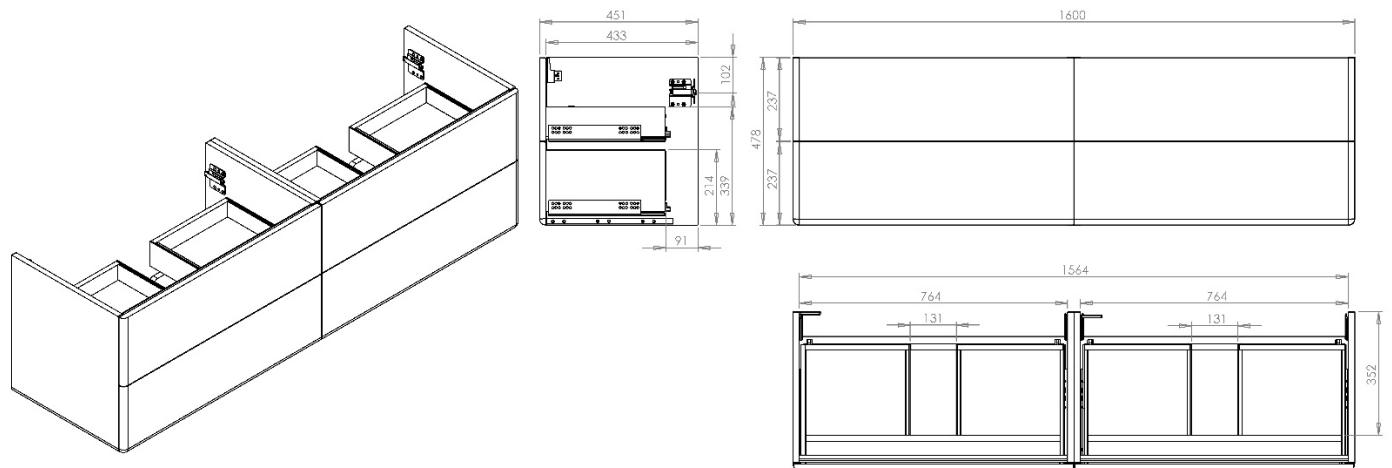

All dimension in mm. Please check dimensions prior to installation as they can vary due to manufacturing tolerances.

**Product Details**

Type:	Twin Double Drawer Washbasin Unit
Width:	1600
Depth:	451
Height:	478
Product Weight*:	64.4kg
Tolerances:	+/- 2mm
Guarantee Period:	5 Years (For Domestic Use) 1 Years (For Commercial Use)
Drawer Box Capacity:	30kg

**Product Specification**

Fascia Material:	18mm MDF
Carcass Material:	18mm MDF/16mm MFC
Available accessories:	Please refer to the Pricelist for further details
Opening Mechanism:	Push to Open
Adjustable Legs:	N/A
Quantity of Shelves:	N/A
Shelving Type:	N/A
Handing:	N/A

\*Product Weight includes packaging.

**Features**

- FSC Certified
- Soft Close
- Assembled
- Handleless
- Push to Open

**Additional Documentation**

Additional Documentation available on our website [www.utopiagroup.com](http://www.utopiagroup.com)

Every effort has been made to ensure that the information provided on this document is correct at the time of creation. Finally, Utopia Furniture Ltd reserve the right to alter materials and specifications in line with continuing programme of production and service development.

**CHIC | TALL STORAGE UNIT - PULL**

**CHC029/\*\*\*, CHC030/\*\*\*,**

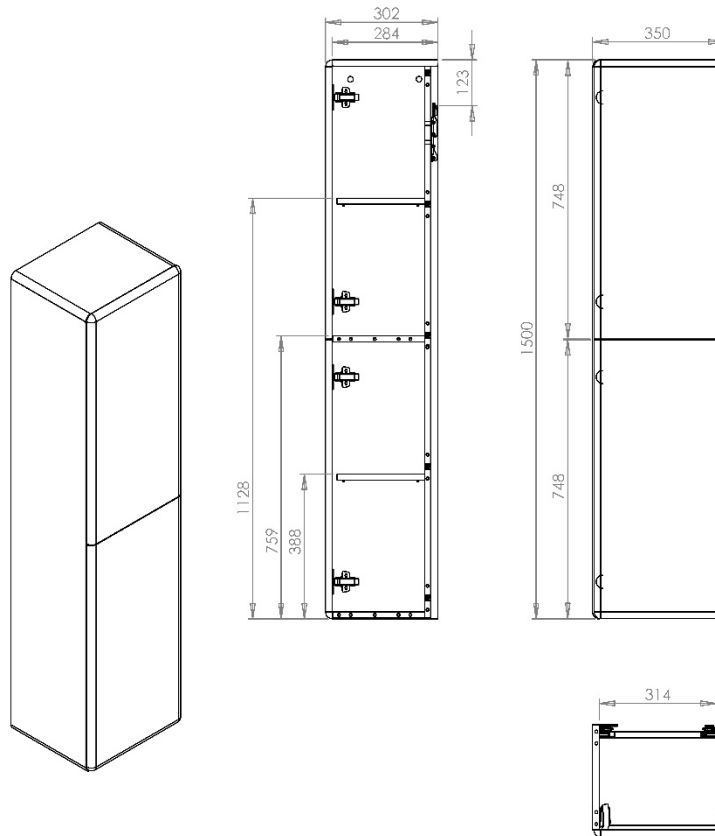

All dimension in mm. Please check dimensions prior to installation as they can vary due to manufacturing tolerances.

**Product Details**

Type:	Tall Storage Unit
Width:	350
Depth:	302
Height:	1500
Product Weight*:	35kg
Tolerances:	+/- 2mm
Guarantee Period:	5 Years (For Domestic Use) 1 Years (For Commercial Use)
Drawer Box Capacity:	N/A

**Product Specification**

Fascia Material:	18mm MDF
Carcass Material:	18mm MDF/16mm MFC
Available accessories:	Please refer to the Pricelist for further details
Opening Mechanism:	Pull Handle
Adjustable Legs:	N/A
Quantity of Shelves:	3 Plus Base
Shelving Type:	MFC
Handing:	Available Left or Right Hand

\*Product Weight includes packaging.

**Features**

- FSC Certified
- Soft Close
- Assembled

**Additional Documentation**

Additional Documentation available on our website [www.utopiagroup.com](http://www.utopiagroup.com)

Every effort has been made to ensure that the information provided on this document is correct at the time of creation. Finally, Utopia Furniture Ltd reserve the right to alter materials and specifications in line with continuing programme of production and service development.



**CHIC | TALL STORAGE UNIT - P2Open\***

CHC031/\*\*\*, CHC032/\*\*\*,

\*Push to Open

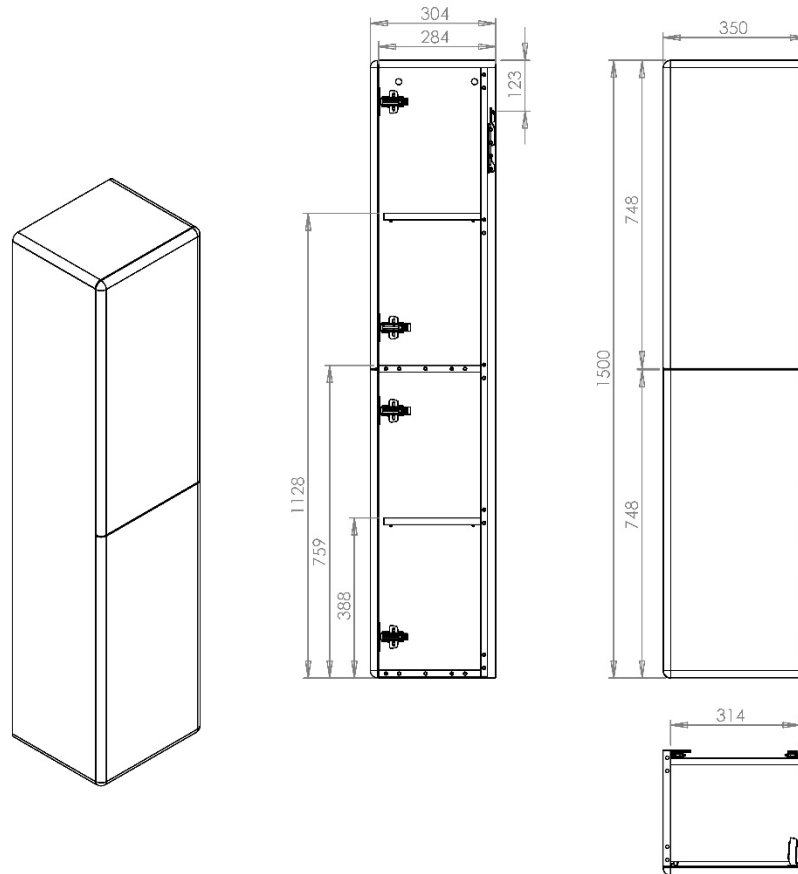

All dimension in mm. Please check dimensions prior to installation as they can vary due to manufacturing tolerances.

**Product Details**

**Product Specification**

Type:	Tall Storage Unit
Width:	350
Depth:	304
Height:	1500
Product Weight*:	35kg
Tolerances:	+/- 2mm
Guarantee Period:	5 Years (For Domestic Use) 1 Years (For Commercial Use)
Drawer Box Capacity:	N/A

Fascia Material:	18mm MDF
Carcass Material:	18mm MDF/16mm MFC
Available accessories:	Please refer to the Pricelist for further details
Opening Mechanism:	Push to Open
Adjustable Legs:	N/A
Quantity of Shelves:	3 Plus Base
Shelving Type:	MFC
Handing:	Available Left or Right Hand

\*Product Weight includes packaging.

**Features**

- FSC Certified
- Soft Close
- Assembled
- Handleless
- Push to Open

**Additional Documentation**

Additional Documentation available on our website [www.utopiagroup.com](http://www.utopiagroup.com)

Every effort has been made to ensure that the information provided on this document is correct at the time of creation. Finally, Utopia Furniture Ltd reserve the right to alter materials and specifications in line with continuing programme of production and service development.

**CHIC | TOILET UNIT 500**

CHC033/\*\*\*,

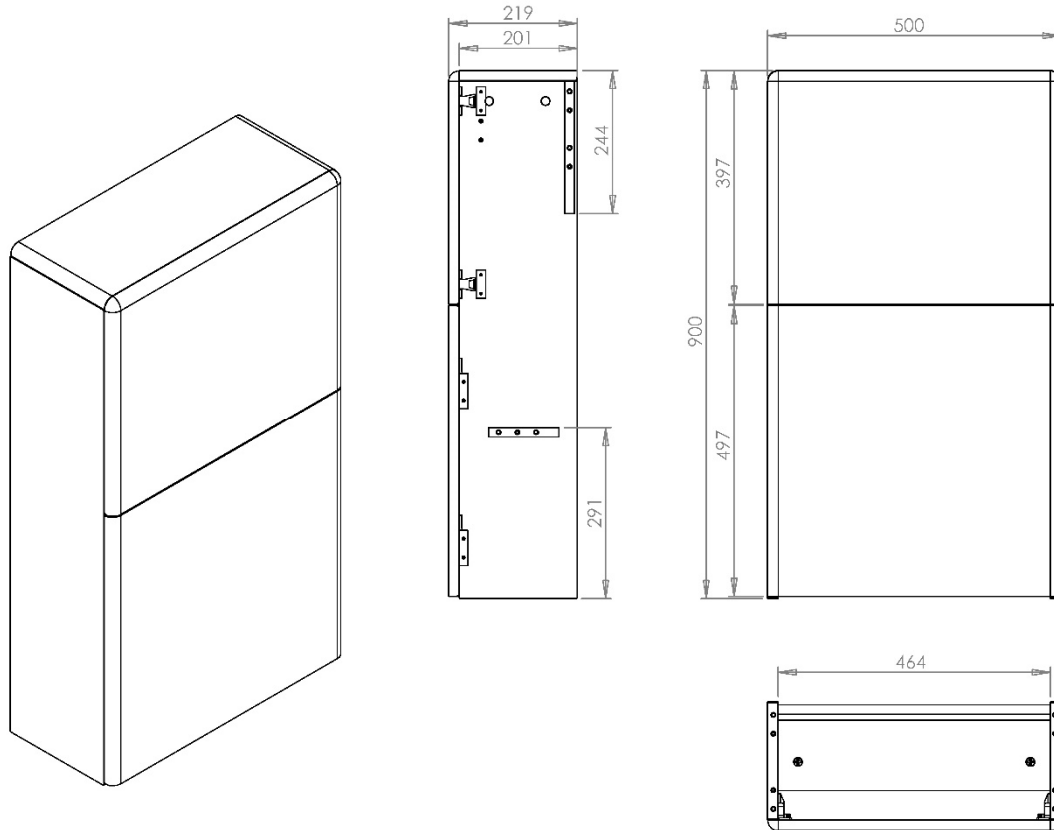

All dimension in mm. Please check dimensions prior to installation as they can vary due to manufacturing tolerances.

**Product Details**

Type:	Toilet Unit
Width:	500
Depth:	219
Height:	900
Product Weight*:	18.3kg
Tolerances:	+/- 2mm
Guarantee Period:	5 Years (For Domestic Use) 1 Years (For Commercial Use)
Drawer Box Capacity:	N/A

**Product Specification**

Fascia Material:	18mm MDF
Carcass Material:	18mm MDF/16mm MFC
Available accessories:	Please refer to the Pricelist for further details
Opening Mechanism:	N/A
Adjustable Legs:	N/A
Quantity of Shelves:	N/A
Shelving Type:	N/A
Handing:	N/A

\*Product Weight includes packaging.

**Features**

- FSC Certified
- Assembled

**Additional Documentation**

Additional Documentation available on our website [www.utopiagroup.com](http://www.utopiagroup.com)

Every effort has been made to ensure that the information provided on this document is correct at the time of creation. Finally, Utopia Furniture Ltd reserve the right to alter materials and specifications in line with continuing programme of production and service development.

**CHIC | TOILET UNIT 600**

CHC034/\*\*\*,

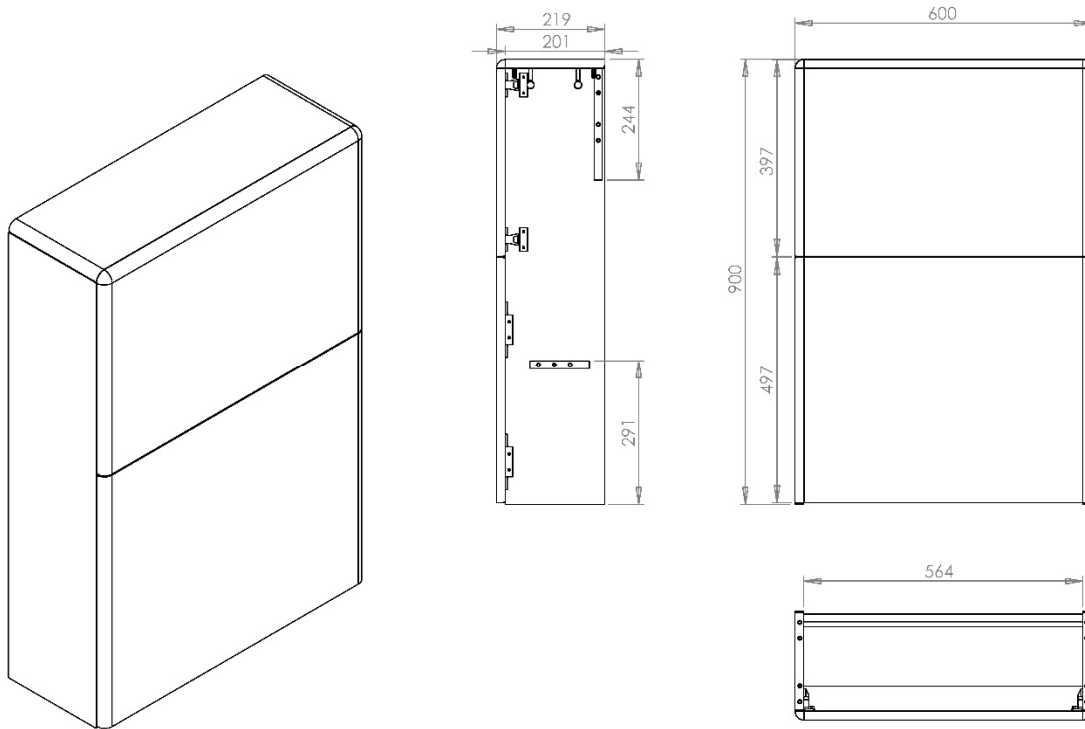

All dimension in mm. Please check dimensions prior to installation as they can vary due to manufacturing tolerances.

**Product Details**

Type:	Toilet Unit
Width:	600
Depth:	220
Height:	900
Product Weight*:	20.00kg
Tolerances:	+/- 2mm
Guarantee Period:	5 Years (For Domestic Use) 1 Years (For Commercial Use)
Drawer Box Capacity:	N/A

**Product Specification**

Fascia Material:	18mm MDF
Carcass Material:	18mm MDF/16mm MFC
Available accessories:	Please refer to the Pricelist for further details
Opening Mechanism:	N/A
Adjustable Legs:	N/A
Quantity of Shelves:	N/A
Shelving Type:	N/A
Handing:	N/A

\*Product Weight includes packaging.

**Features**

- FSC Certified
- Assembled

**Additional Documentation**

Additional Documentation available on our website [www.utopiagroup.com](http://www.utopiagroup.com)

Every effort has been made to ensure that the information provided on this document is correct at the time of creation. Finally, Utopia Furniture Ltd reserve the right to alter materials and specifications in line with continuing programme of production and service development.

**CHIC | TOILET UNIT 500 INC CONCEALED CISTERN**

CHC035/\*\*\*,

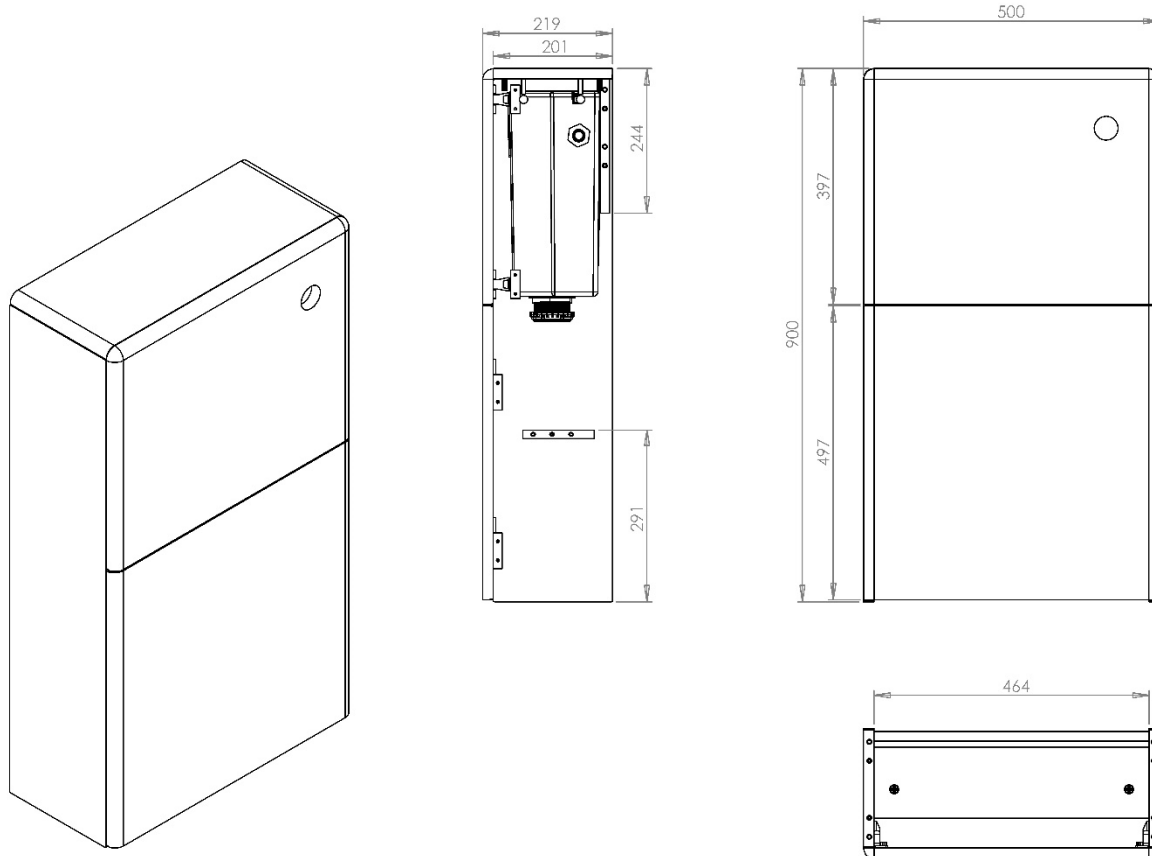

All dimension in mm. Please check dimensions prior to installation as they can vary due to manufacturing tolerances.

**Product Details**

Type:	Toilet Unit Inc Concealed Cistern
Width:	500
Depth:	219
Height:	900
Product Weight*:	20.00kg
Tolerances:	+/- 2mm
Guarantee Period:	5 Years (For Domestic Use) 1 Years (For Commercial Use)
Drawer Box Capacity:	N/A

**Product Specification**

Fascia Material:	18mm MDF
Carcass Material:	18mm MDF/16mm MFC
Available accessories:	Please refer to the Pricelist for further details
Opening Mechanism:	N/A
Adjustable Legs:	N/A
Quantity of Shelves:	N/A
Shelving Type:	N/A
Handing:	N/A

\*Product Weight includes packaging.

**Features**

- FSC Certified
- Assembled
- Concealed Cistern Included

**Additional Documentation**

Additional Documentation available on our website [www.utopiagroup.com](http://www.utopiagroup.com)

Every effort has been made to ensure that the information provided on this document is correct at the time of creation. Finally, Utopia Furniture Ltd reserve the right to alter materials and specifications in line with continuing programme of production and service development.

**CHIC | TOILET UNIT 600 INC CONCEALED CISTERN**

**CHC036/\*\*\*,**

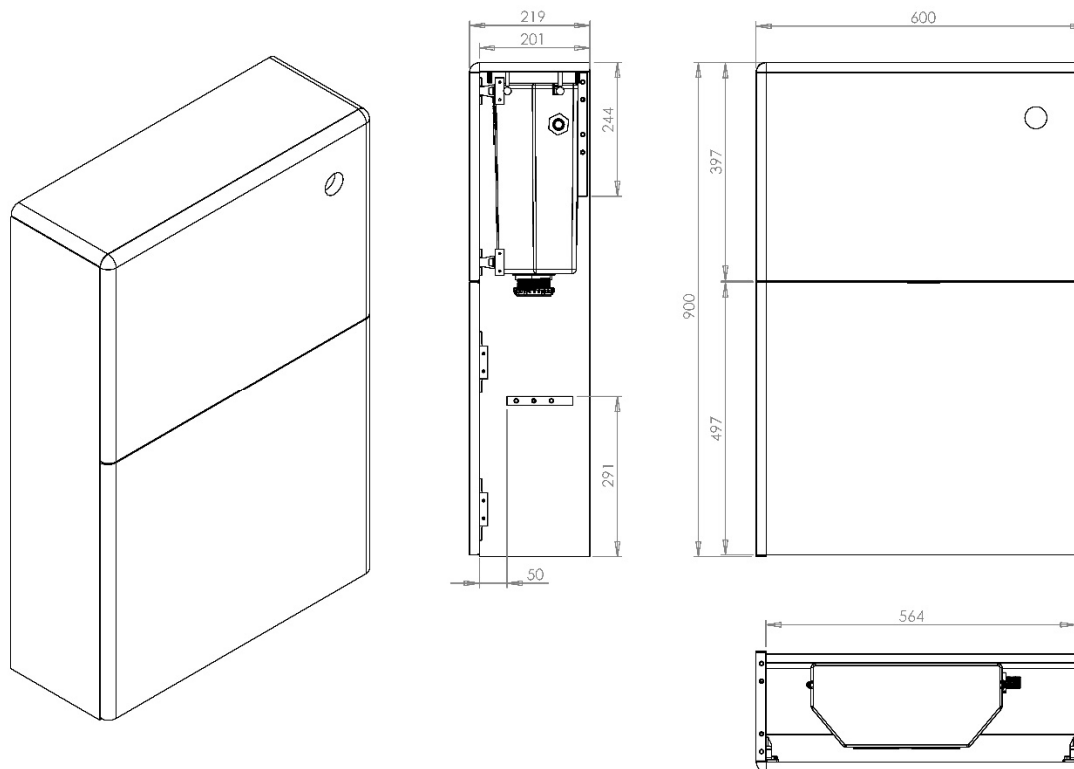

All dimension in mm. Please check dimensions prior to installation as they can vary due to manufacturing tolerances.

**Product Details**

Type:	Toilet Unit Inc Concealed Cistern
Width:	600
Depth:	219
Height:	900
Product Weight*:	20.30kg
Tolerances:	+/- 2mm
Guarantee Period:	5 Years (For Domestic Use) 1 Years (For Commercial Use)
Drawer Box Capacity:	N/A

**Product Specification**

Fascia Material:	18mm MDF
Carcass Material:	18mm MDF/16mm MFC
Available accessories:	Please refer to the Pricelist for further details
Opening Mechanism:	N/A
Adjustable Legs:	N/A
Quantity of Shelves:	N/A
Shelving Type:	N/A
Handing:	N/A

\*Product Weight includes packaging.

**Features**

- FSC Certified
- Assembled
- Concealed Cistern Included

**Additional Documentation**

Additional Documentation available on our website [www.utopiagroup.com](http://www.utopiagroup.com)

Every effort has been made to ensure that the information provided on this document is correct at the time of creation. Finally, Utopia Furniture Ltd reserve the right to alter materials and specifications in line with continuing programme of production and service development.